



distinctly

abode



FROM OUR
FAMILY
 TO YOURS, WE INSPIRE
 & ENHANCE HOMES
 WITH HEART & PASSION
 IN EVERYTHING WE DO



FRIENDLY
 AWARD WINNING
 COMMITTED
 INNOVATIVE
 QUALITY
 INTEGRITY



Scan the QR code to access our 2022 sustainability report which sets out the way in which environmental, social and governance issues are managed, explaining the ESG credentials which mean customers can trust Abode as a partner for the long term.



ABODE KITCHEN SINKS AND TAPS ARE CREATED FOR PEOPLE WHO WANT THE PERFECT BLEND OF DESIGN, PERFORMANCE AND SHEER QUALITY.

All Abode products are lovingly crafted and thoroughly tested in our factories prior to making the journey to the centre of your kitchen and daily life.

Buying Abode means complete peace of mind. We have strict quality standards, investing in the very best components and latest manufacturing techniques to ensure long-life performance. We are so confident in the quality of our products that they carry a comprehensive warranty. On top of that, our UK aftersales service team are dedicated in providing superior customer service should you ever need us.



Full details of our warranties can be found on our website;

www.abodedesigns.co.uk/support/warranty



Keep up to date with the very latest product introductions, news and find a wealth of inspiration from our pages below;

 www.abodedesigns.co.uk  [Instagram.com/abode_home](https://www.instagram.com/abode_home)

 [Pinterest.co.uk/AbodeDesigns](https://www.pinterest.co.uk/AbodeDesigns)

 [Facebook.com/abodehomeproducts](https://www.facebook.com/abodehomeproducts)  [Twitter.com/abodehome](https://www.twitter.com/abodehome)

 https://www.youtube.com/channel/UC7D85OOhL8-F_ngwBTOgdsA





Kitchen Sinks



CONTENTS

Stainless Steel Undermounts	14
Granite Undermounts	36
Ceramic Undermounts	44
Granite Insets	54
Ceramic Insets	72
Stainless Steel Insets	78
Sink Wastes and Overflows	94
Taps	98

Scan to view
Kitchen Sinks
Price List



Selecting a Sink

- 1 MATERIAL
- 2 TYPE
- 3 SIZE
- 4 STYLE
- 5 FEATURES



Material

STAINLESS STEEL: Stainless Steel is a timeless material which remains a popular choice. It is often a perfect match to the kitchen appliances so provides a coordinated finishing touch. As well as the aesthetics, it is easy to maintain and is extremely durable. All Abode sinks are constructed from premium 304 grade stainless steel and are available in an array of designs.

- HYGIENIC
- EASY TO CLEAN
- HIGH HEAT RESISTANCE
- STAIN RESISTANT
- CORROSION RESISTANT
- PREMIUM GRADE STAINLESS STEEL

GRANITE: SiOForm® is a unique material solution engineered specially for our granite kitchen sink collection. The material is primarily made of pure and natural quartz, a material that is strong, resilient and extremely durable, making it an ideal addition for your kitchen. SiOForm® products have a uniform void-free structure and are resistant to dry temperatures up to 280°. Granite sinks are great for retaining water temperature, making it perfect for any busy kitchen environment. Our range consists of several unique designs in various shapes and sizes. Additionally, the Frost White, Grey Metallic and Black Metallic options add a premium and contemporary touch and create a striking focal point in your kitchen.

- HYGIENIC
- EASY TO CLEAN
- UNIFORM STRUCTURE
- HIGH CONTENT OF NATURAL MINERAL
- STAIN RESISTANT
- SCRATCH RESISTANT
- IMPACT RESISTANT
- THERMAL SHOCK RESISTANT
- SURFACE ABRASION RESISTANT

SiOForm® is available in the following colours:

- WHITE GRANITE
- FROST WHITE
- GREY METALLIC
- BLACK METALLIC
- BLACK GRANITE

CERAMIC: Our ceramic sinks are constructed from the finest grade fireclay and are hand finished for a premium quality finish. This traditional classic is available in undermount, apron front and inset options, providing an elegant finish every time. The glazing process ensures a long lasting and durable finish.

- HYGIENIC
- EASY TO CLEAN
- HIGH HEAT RESISTANCE
- STAIN RESISTANT
- CHEMICAL RESISTANT
- DURABLE AND LONG LASTING

Sink types



UNDERMOUNT: An undermount sink is installed under the worktop for a seamless, premium finish. Undermount sinks will work with a wide variety of worktop surfaces. Why not try pairing yours with a solid surface or granite worktop? There are a large range of bowl sizes and configurations to choose from in this offer, providing ultimate versatility when it comes to usage requirements. The tap is often mounted on the worktop, adding to the premium, sleek look.



INSET: An inset sink sits on top of the worktop and can be installed in any material, including laminate. An inset sink will often have a drainer integrated for ease and durable functionality. The tap is usually mounted on the sink and often these designs have two tap holes so they are reversible, meaning the drainer can be positioned either left or right.

APRON FRONT: This range consists of our Belfast and Provincial products. They are installed under the worktop with the front face visible so require a base cabinet with a specific height to house them. Traditionally these products are ceramic, for a more contemporary/industrial style, opt for the stainless steel Belfast.

Sink sizes



Across our comprehensive sink collection, we have several sink sizes available. In the initial planning stages, it is important to consider how the kitchen is to be used to determine which option is best suited to your lifestyle requirements.

How do you use your sink? What would make your daily tasks easier so you can focus on the more important things? for example; what typically needs to fit in the main bowl? Is a larger main bowl size needed? Would the addition of a half bowl be beneficial? Is a drainer required?

EXAMPLES ARE AS FOLLOWS;

- Single Half Bowl
- Single Bowl
- 1.5 Bowl
- Double Bowl
- Large & Extra Large Bowl options



Sink features

LOOK OUT FOR THE FOLLOWING FEATURES ON SELECTED SINK RANGES



FLUSH PLATE OVERFLOW

This removable overflow cover has the following benefits;
Removable for improved sink hygiene (easy clean)
Provides a sleek, premium finish
Constructed from solid stainless steel



ORBIT WASTE

Provides a minimalist look, whilst removing unsightly debris from view
Constructed from stainless steel and rubberised plastic
Dishwasher safe, as well as being easy to empty



TOP MOUNTED OVERFLOW

Allows for maximum bowl filling
Dispose of drinks even when the bowl is full
Applies to the Neron range only

All Abode Sinks are supplied with pipework

Look out for the following symbols throughout this section:

REVERSIBLE
Overflow or drainer can be positioned either left or right.

2ND TAP HOLE FOR SWITCH

Style

The overall style of the kitchen will go a way to dictate the perfect sink and tap pairing. Bring colour into the kitchen with a granite sink and either a perfectly matched or contrasting tap pairing.

For example; an industrial style kitchen with dark colourways looks great with a stainless steel or granite sink plus a perfectly matched tap in stainless steel, black, or graphite. However, consider the finer details such as the handles or any key detailing on appliances/ accessories in the kitchen when selecting the perfect tap finish, it may be that a brass or copper tone is more suited to complement the kitchen overall.

STAINLESS STEEL UNDERMOUNTS

Understated simplicity

It's not just the material that's versatile but the range of products in this offer.

We're confident you'll find the perfect solution from our stainless steel undermount collection. Whether you're looking for a small single bowl, one and a half bowl, large bowl or even an extra large bowl!

We also have ranges which allow you to create the undermount look without the expense of solid surface. Take a look at our R15 range which can be either undermounted or inset so worktop material doesn't restrict you from creating the look you desire.



Image shows the System Sync Large Single Bowl and Accessory Trio with Genio Semi-Professional Monobloc pull around in Matt Black



SYSTEM SYNC

The innovative System Sync, designed to work with you and your kitchen.

Overflowing with features and versatility that offers up superlative functionality, maximises workflow, and liberates worktops.

With the combination of bowl sizes available, flexible 2IN1 installation, integrated smart rail and a range of accessories,

System Sync offers so much more than bowls to simply wash up in, it allows for a whole host of kitchen tasks to be performed super efficiently - saving time and space for those things that matter.

System Sync bowls have been expertly crafted from 0.8mm 304 grade brushed stainless steel to ensure a finish that is as durable as it is sleek and stylish.

All accessories are tailored to fit System Sync perfectly and are stackable to further optimise space.

Simplify. Streamline. Synchronise
with **System Sync**

Streamline, Simplify, Synchronise

with
SYSTEM
SYNC



From the *Micro* to the *Mega*

Open up a world of possibilities and build your perfect sink solution with System Sync, allowing you to create a customisable, smart solution for all kinds of spaces, from the small to the spacious.

Full specification documents can be found at www.abodedesigns.co.uk

1/ SELECT YOUR BOWL / BOWL COMBINATION

Caddy Bowl (180mm)



AW5141
Stainless Steel

length 440mm
width 220mm
depth 150mm
bowl I capacity 5.6L
min base unit 450mm

Can be undermounted or inset

Single bowl (340mm)



AW5142
Stainless Steel

length 380mm
width 340mm
depth 150mm
bowl I capacity 16.7L
min base unit 450mm

Can be undermounted or inset

Large single bowl (500mm)



AW5143
Stainless Steel

length 440mm
width 500mm
depth 200mm
bowl I capacity 24.90L
min base unit 600mm

Can be undermounted or inset

2/ SELECT ACCESSORIES

Abode recommends opting for the Accessory Trio which includes; a FlexRack which offers limitless uses, whether it's keeping hot pans away from your worktop or utilising it as a draining board after you've been cooking up a storm. The multi-functional prep board and colander. The complete solution to make meal preparation a breeze. However each accessory is available individually if you prefer.

Accessory trio



AX1142

Includes:

- **AX2024** System Sync Prep board
- **AX1508** System Sync Colander
- **AX2506** System Sync Flex Rack

NEW

MATRIX R0

This elegant undermount option brings a sharp geometry to the kitchen, complementing popular appliance styling. These precision engineered pieces give a premium finish every time.

1mm durable 304 grade brushed stainless steel construction

Squared edges. Zero-radius construction

Deep bowls to accept larger cookware

Orbit wastes with easy empty, fold-back basket and pipework included

Easy clean flush-plate overflow



MATRIX R0

Single half bowl



AW5007
Stainless Steel

length 200mm
width 440mm
depth 155mm
bowl 1 capacity 6.3L
min base unit 450mm

Undermount only

Main bowl



AW5008
Stainless Steel

length 380mm
width 438mm
depth 205mm
bowl 1 capacity 21.2L
min base unit 450mm

Undermount only

Large single main bowl



AW5009
Stainless Steel

length 540mm
width 440mm
depth 205mm
bowl 1 capacity 31.2L
min base unit 600mm

Undermount only



1.5 bowl



AW5010-2
Stainless Steel
right hand main bowl

AW5011-2
Stainless Steel
left hand main bowl

length 556mm
width 460mm
depth 205mm
bowl 1 capacity 21.2L
min base unit 600mm

Undermount only

Double bowl



AW5012-2
Stainless Steel

length 736mm
width 460mm
depth 205mm
bowl 1 capacity 21.2L
min base unit 800mm

Undermount only



Full specification documents can be found at www.abodedesigns.co.uk



Low profile inset installation

MATRIX R15

Minimal and modern in design, maximal in versatility, the Matrix R15 is expertly crafted using the latest pressing technology in the highest quality stainless steel. Timeless in style, easy to maintain and extremely durable, this collection is both stylish and streamlined, blending contemporary design with practical versatility and will sit well in any busy kitchen. Keen cook or entertain often? You'll love the extra-large bowl that fits large pots, pans and trays with ease.

1mm durable 304 grade brushed stainless steel construction

Orbit wastes with easy empty, fold-back basket and pipework included

Minimal 15mm radius corners. Stylish yet still easy to clean

Deep bowls and good breadth of range

With easy clean flush-plate overflow

Inset and Undermount install: 2IN1



Undermount installation

Image shows the Matrix R15 Single Bowl and Prothia Slimline Monobloc Swan in Chrome

MATRIX R15

Single bowl



AW5121
Stainless Steel

length 380mm
width 440mm
depth 202mm
bowl 1 capacity 18.5L
min base unit 500mm

Can be undermounted or inset

Large single bowl



AW5122
Stainless Steel

length 540mm
width 440mm
depth 205mm
bowl 1 capacity 27.6L
min base unit 600mm

Can be undermounted or inset

Extra large single bowl



AW5128
Stainless Steel

length 750mm
width 440mm
depth 205mm
bowl 1 capacity 43L
min base unit 1000mm

Can be undermounted or inset

Double bowl



AW5123
Stainless Steel

length 740mm
width 440mm
depth 202mm
bowl 1 capacity 18.5L
min base unit 800mm

Can be undermounted or inset

1.5 bowl



AW5124
Stainless Steel
left hand main bowl

AW5126
Stainless Steel
right hand main bowl

length 580mm
width 440mm
depth 202mm
bowl 1 capacity 18.5L
min base unit 800mm

Can be undermounted or inset



1.5 large bowl



AW5125
Stainless Steel
left hand main bowl

AW5127
Stainless Steel
right hand main bowl

length 740mm
width 440mm
depth 205mm
bowl 1 capacity 27.6L
min base unit 800mm

Can be undermounted or inset



Full specification documents can be found at www.abodedesigns.co.uk

MATRIX R50

The Matrix R50 range is designed to enable a combination approach to your sink layout or for a single product installation. With smooth contoured bowl edges for a sleek finish.

0.7mm 304 grade polished stainless steel construction

50mm radius corners for ease of cleaning

Orbit wastes with easy empty, fold-back basket and pipework included

Six bowl sizes to choose from



Image shows the R50 1.5 Bowl and Prothia Quad Spout in Matt Black

MATRIX R50

Single half bowl



AW5013
Stainless Steel

length 168mm
width 318mm
depth 155mm
bowl 1 capacity 4.4L
min base unit 450mm
Undermount only

Main bowl



AW5014
Stainless Steel

length 370mm
width 430mm
depth 205mm
bowl 1 capacity 20.3L
min base unit 450mm
Undermount only

Large single bowl



AW5015
Stainless Steel

length 535mm
width 435mm
depth 205mm
bowl 1 capacity 37.0L
min base unit 600mm
Undermount only

1.5 bowl



AW5017
Stainless Steel
left hand main bowl

AW5016
Stainless Steel
right hand main bowl

length 572mm
width 450mm
depth 205mm
bowl 1 capacity 20.3L
min base unit 600mm
Undermount only



Full specification documents can be found at www.abodedesigns.co.uk

STAINLESS STEEL BELFAST

A contemporary twist on a classic to create a true showstopper that adds a touch of modernism to any kitchen. Its large capacity bowl is ideally suited to keen cooks and aspiring chefs as large pots, pans and trays fit in with ease. Why not pair this sink with one of our professional or Hex taps to add a true industrial edge to your kitchen?

Single bowl

1.2mm thick 304 grade brushed stainless steel

Orbit waste with easy empty, fold-back basket and pipework included

90mm waste hole to accept waste disposal unit

Flush-plate overflow for a sleek contemporary look

Sit on installation

Fits 600mm Belfast base units



AW5135

Stainless Steel

length 600mm
width 465mm
depth 254mm
bowl 1 capacity 38.1L
min base unit 600mm

Full specification documents can be found at www.abodedesigns.co.uk



Image shows the Stainless Steel Belfast and HEX Professional

STUDIO COMPACT

The Studio was designed for compact kitchens and grander installations alike. In smaller kitchens maximise worktop space thanks to Studio's compact yet functional proportions, or install as a practical preparation sink, ideally suited for steaming hot water taps. Three accessories are supplied with the Studio sink, adding useful functionality where space is limited.

Two installation options available:

600mm cabinet requirement in horizontal mounting position (450mm in vertical)

Low profile inset or undermount installation

1mm 304 grade brushed stainless steel

Small radius bowl corners for contemporary style with effortless cleaning

Orbit waste with easy empty, fold-back basket and pipework included

Flush-plate overflow for a sleek contemporary look

Single bowl



AW5134

Stainless Steel

length 500mm

width 300mm

depth 205mm

bowl 1 capacity 16.9L

min base unit 450mm (vertical mounting)

600mm (horizontal mounting)



Comes complete with 3 practical accessories; strainer, colander and mini bowl in the pack

Full specification documents can be found at www.abodedesigns.co.uk



GRANITE UNDERMOUNTS

Find the perfect match for your décor with our range of granite sinks. Available in three colours; black, grey and white there is sure to be something to suit your requirements. Our black and grey options have a metallic fleck to ensure a premium finish.

For details on the benefits of our SioForm® granite composition see page 09.



Image shows the Matrix GR15 2 Bowl In Black Metallic Granite and Virtue Nero Pull Out

MATRIX GR15

Beautifully versatile. The GR15 collection has a smooth contoured body offering a seamless finish. Choose from four different bowl sizes and three different granite colours, all of which have two installation options.

Pure and natural quartz construction for ultimate durability

Can be undermounted or inset in worktops

Resistant to temperatures up to 280°C, surface abrasion and scratches. Long-lasting quality

Smooth surface finish

Softened square edges for a crisp look whilst remaining easy to clean

Orbit wastes with easy empty, fold-back basket and pipework included



Image shows the Matrix GR15 1.5 Bowl in Black Metallic Granite and Pico Monobloc in Brushed Nickel

MATRIX GR15

Single bowl



AW3124
Black Metallic Granite

AW3125
White Granite

AW3133
Grey Metallic Granite

length 460mm
width 460mm
depth 220mm
bowl 1 capacity 20.8L
min base unit 500mm

**Can be undermounted
or inset**

Large main bowl



AW3126
Black Metallic Granite

AW3127
White Granite

AW3134
Grey Metallic Granite

length 560mm
width 460mm
depth 225mm
bowl 1 capacity 26L
min base unit 600mm

**Can be undermounted
or inset**

1.5 bowl [reversible*]



AW3128
Black Metallic Granite

AW3129
White Granite

AW3135
Grey Metallic Granite

length 560mm
width 460mm
depth 220mm
bowl 1 capacity 14L
min base unit 600mm

**Can be undermounted
or inset**

Double bowl



AW3166
Black Metallic Granite

AW3165
Grey Metallic Granite

length 758mm
width 460mm
depth 220mm
bowl 1 capacity 16.8L
min base unit 800mm

Undermount only

Full specification documents can be
found at www.abodedesigns.co.uk

* Handing as shown (left hand main bowl) sets waste slightly towards the back of sink cabinet. Right hand main bowl installations are valid, but wastes will be offset slightly forward. For more info see full specification sheet on our website.



DENTON

Perfect for compact kitchens and grander installations alike. In smaller spaces maximise worktop area thanks to Denton's small proportions or install as a practical preparation sink in a kitchen island unit as an addition to the main kitchen sink.

Single bowl

Durable and hygienic composite granite construction with high temperature resistance (280°C)

Compact design ideally suited for smaller installations or perfect as a second sink

Undermount installation

600mm cabinet requirement in horizontal mounting position or 450mm in the vertical position

Designed with small radius corners for a sharp look whilst remaining easy to clean

Orbit waste with easy empty, fold-back basket and pipework included



AW3167

Grey Metallic Granite

length 500mm
width 363mm
depth 198mm
bowl 1 capacity 12.1L
min base unit 450mm or 600mm

Can be undermounted or inset

Denton shown with AX2024 System Sync Prep Board.
See page 19 for details.



Full specification documents can be found at www.abodedesigns.co.uk



CERAMIC UNDERMOUNTS

Ceramic sinks are often perceived purely as a traditional option for a traditional setting, however this range of products is extremely adaptable. Try pairing with a contemporary tap in the finish of the moment for a striking effect.



Image shows the Belfast and ProTrad 3IN1 in Brushed Nickel.



BELFAST

A true classic! The Belfast sink is a staple when it comes to a traditional kitchen, not only does it sit beautifully in any kitchen setting, but it has a large bowl capacity making it perfect for the busy household or keen cook. Try mixing this classic sink with a contemporary tap to inject a modern twist, suitably paired with the other finer details of your kitchen design.

Large bowl
[reversible]



- Durable finest grade fireclay construction throughout
- High capacity bowl volume to accept larger cookware
- 60mm basket strainer waste supplied
- Smooth, contoured integral weir overflow built-in

AW1022
White Ceramic



length 595mm
width 455mm
depth 275mm
bowl 1 capacity 42.3L
min base unit 600mm

Full specification documents can be found at www.abodedesigns.co.uk

PROVINCIAL

Timeless in design and natural in form, the Provincial captures the true essence of British sense of style, delivering elegance, beauty, and functionality as standard. The larger bowl capacity maximises kitchen workflow and takes larger pots, pans, and trays with ease, making it the perfect addition for busy households and keen cooks.

Large single bowl



AW1020

White Ceramic

length 795mm
width 460mm
depth 220mm
bowl 1 capacity 37.7L
min base unit 800mm

Large double bowl



AW1021

White Ceramic

length 794mm
width 490mm
depth 220mm
bowl 1 capacity 20.1L
min base unit 800mm

Durable finest grade fireclay construction throughout

High capacity bowl volume to accept larger cookware

90mm basket strainer waste(s) supplied

Punched tap hole on the 2 bowl version

Worktop can be cut to cover tap deck (as shown right)

Full specification documents can be found at www.abodedesigns.co.uk



Image shows the Provincial Large Double Bowl and Astbury Bridge with Handspray in Chrome (see Classically Abode brochure)

SANDON

This versatile range offers the possibility of seamless integration with undermount installation or simplicity with inset installation. Available in a variety of bowl sizes this collection will sit beautifully in traditional or contemporary settings alike.

Durable finest grade fireclay construction throughout

Orbit wastes with easy empty, fold-back basket and pipework included

Modern flush-plate overflow

Wide variety of design options



Image shows the Sandon Large Single Bowl and HEX Single Lever in Antique Brass

SANDON



Image shows the Sandon 1.5 Bowl and Prothia Slimline Monobloc Quad Spout in Brushed Nickel

Single bowl



AW1030
White Ceramic

length 460mm
width 460mm
depth 220mm
bowl 1 capacity 19.5L
min base unit 500mm [if inset],
600mm [if undermounted]

Can be undermounted or inset

Large single bowl



AW1031
White Ceramic

length 595mm
width 460mm
depth 220mm
bowl 1 capacity 26.3L
min base unit 600mm [if inset],
800mm [if undermounted]

Can be undermounted or inset

1.5 bowl [with tap gap]



AW1032
White Ceramic

length 595mm
width 520mm
depth 220mm
bowl 1 capacity 26.5L
min base unit 600mm [if inset],
800mm [if undermounted]

Can be undermounted or inset

1.5 bowl



AW1033
White Ceramic

length 595mm
width 460mm
depth 220mm
bowl 1 capacity 21.5L
min base unit 600mm [if inset],
800mm [if undermounted]

Can be undermounted or inset

Shown with intended, left-hand main bowl
handing. N.B. overflow will be on opposite
side if mounting right-hand-main bowl

Full specification documents can be found at www.abodedesigns.co.uk

GRANITE INSETS

Our range of inset granite sinks are truly distinctive. There are models with curvaceous contours and drainers with real design flair. These sinks don't only have big personality, they have true functionality. With 5 colours available across the range and all models constructed from our SiOForm® material, these sinks are as durable as they are striking.

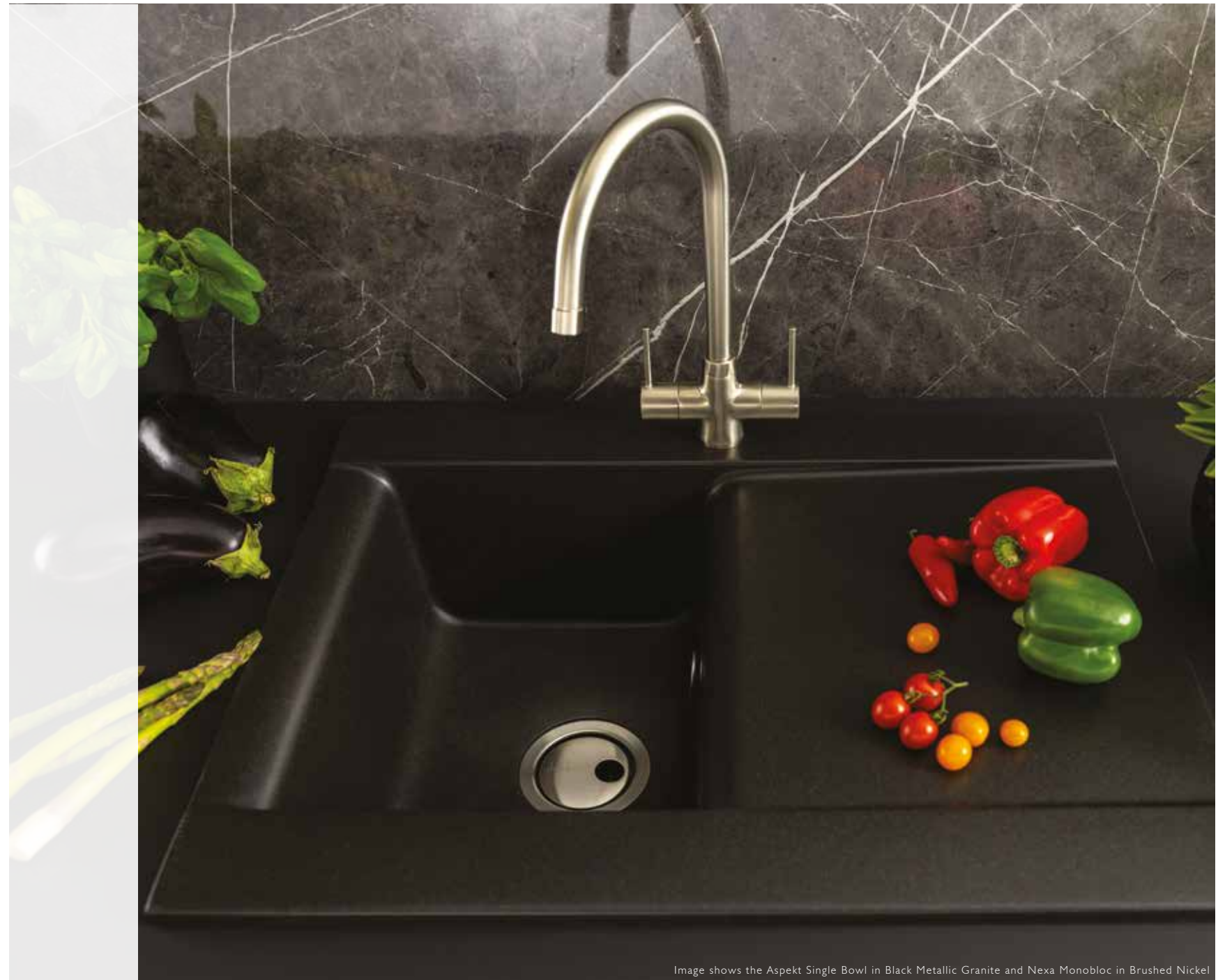



Image shows the Aspekt Single Bowl in Black Metallic Granite and Nexa Monobloc in Brushed Nickel

ASPEKT

The curvaceous contours of the Aspekt make this sink a truly showstopping piece in any kitchen. The way the drainer flows down into the main bowl is a thing of elegance, all contrasted with square edges for a sharp and striking finish.

Single bowl and drainer
[reversible]



AW3001
Black Metallic Granite  

AW3101
White Granite

length 716mm
width 540mm
depth 205mm
bowl | capacity 10.46L
min base unit 450mm

1.5 bowl and drainer
[reversible]



AW3002
Black Metallic Granite  

AW3102
White Granite

length 950mm
width 540mm
depth 205mm
bowl | capacity 9.17L
min base unit 600mm



The black option features a discreet metallic fleck adds a premium finish to your kitchen. The white offers a pure, natural finish that will provide the perfect finishing touch in most interiors

Orbit wastes with easy empty fold-back basket and pipework supplied

Full specification documents can be found at www.abodedesigns.co.uk



Image shows the Aspekt Single Bowl in White Granite and Nexa Monobloc in Chrome

DUNE

Taking its name from the signature drainer design, mimicking the soft peaks that are formed across sand dunes. The Abode Dune is truly natural and organic in form, a soft silhouette with rounded corners that follow through into the bowl and styling allow for a striking yet functional focal point in any kitchen.

Hidden Orbit overflow design

Orbit wastes with easy empty fold-back basket and pipework supplied



Image shows the Dune 1.5 Bowl in Frost White Granite and Pico Monobloc in Brushed Brass

DUNE

Single bowl and drainer
[reversible]



AW3140
Black Granite



AW3141
Frost White Granite

AW3144
Grey Metallic Granite

length 1000mm
width 500mm
depth 217mm
bowl 1 capacity 22.9L
min base unit 600mm

1.5 bowl and drainer
[reversible]



AW3142
Black Granite



AW3143
Frost White Granite

AW3145
Grey Metallic Granite

length 1000mm
width 500mm
depth 217mm
bowl 1 capacity 24.8L
min base unit 600mm

Full specification documents can be found at www.abodedesigns.co.uk



ORIEL

This subtle design is perfectly formed with smooth, organic lines framing the deep bowl. Both styles can be perfectly complemented by an array of tap designs and finishes to create a striking finish.

Single bowl and drainer
[reversible]



AW3112
Black Granite



AW3114
Frost White Granite

length 780mm
width 480mm
depth 200mm
bowl 1 capacity 16L
min base unit 450mm

1.5 bowl and drainer
[reversible]



AW3113
Black Granite



AW3115
Frost White Granite

length 950mm
width 480mm
depth 200mm
bowl 1 capacity 16L
min base unit 600mm

Reversible drainer position for
maximum flexibility

90mm stainless steel basket strainer
waste(s) supplied

Pipework supplied



Image shows the Oriel 1.5 Bowl in Black Granite and Pico Monobloc in Matt Black

Full specification documents can be found at www.abodedesigns.co.uk

XCITE

Strong geometric design with sharp edging and a defined straight drainer pattern is the back bone to the contemporary family. The bowls feature softened square edges for a defined look whilst still being easy to clean.

Reversible drainer position for maximum flexibility

90mm stainless steel basket strainer waste(s) supplied

Pipework supplied



XCITE

Single bowl and drainer
[reversible]



AW3168
Black Metallic Granite



AW3120
Frost White Granite

AW3161
Grey Metallic Granite

length 780mm
width 500mm
depth 190mm
bowl 1 capacity 16L
min base unit 450mm

1.5 bowl and drainer
[reversible]



AW3169
Black Metallic Granite



AW3121
Frost White Granite

AW3162
Grey Metallic Granite

length 1000mm
width 500mm
depth 200mm
bowl 1 capacity 16L
min base unit 600mm



Image shows the Xcite Single Bowl in Black Metallic Granite and Althia Single Lever in Brushed Brass

Full specification documents can be found at www.abodedesigns.co.uk

ZERO

Oozing with style and overflowing with functionality, the Abode Zero is as versatile as it is visually exciting. Expertly crafted from our SioForm quartz blend that is as durable as it is striking, easy to clean and resistant to temperatures up to 280°C. With softened, squared edges, streamlined design and generous bowl depth, the Abode Zero is a thing of true design excellence.

Hidden Orbit overflow design

Orbit wastes with easy empty fold-back basket and pipework supplied

With part formed tap holes to be drilled to your preference on installation



ZERO

Single bowl and drainer
[reversible]



AW3007
Black Metallic Granite



AW3107
White Granite

AW3163
Grey Metallic Granite

length 1000mm
width 500mm
depth 220mm
bowl 1 capacity 25.4L
min base unit 600mm

1.5 bowl and drainer
[reversible]



AW3006
Black Metallic Granite



AW3106
White Granite

AW3164
Grey Metallic Granite

length 1000mm
width 500mm
depth 220mm
bowl 1 capacity 29.4L
min base unit 600mm

Single bowl and double drainer
[not handed]

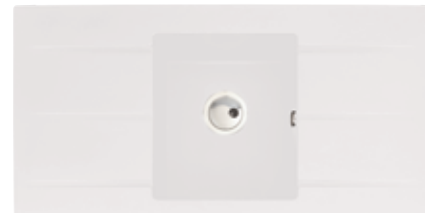

AW3008
Black Metallic Granite



AW3108
White Granite

length 1000mm
width 500mm
depth 220mm
bowl 1 capacity 19.3L
min base unit 450mm

1.5 bowl
[reversible]



AW3005
Black Metallic Granite



AW3105
White Granite

length 600mm
width 500mm
depth 220mm
bowl 1 capacity 29.4L
min base unit 600mm

Full specification documents can be found at www.abodedesigns.co.uk

CERAMIC INSETS

Traditional materials are matched with contemporary designs to create a truly modern and practical offering. This hard-wearing material is the perfect choice for the busy kitchen, it will stand the test of time whilst providing a striking focal point with a perfectly paired tap.



Image shows the Milford Single Bowl and Ludlow Monobloc in Brushed Nickel

ACTON

Traditional material perfectly blended with contemporary design influences makes the Acton the perfect option for those looking to merge the two elements.

Durable finest grade fireclay construction throughout

High capacity bowl volume to accept larger cookware. Maximum main bowl filling due to non-sealing overflow (1.5 bowl only)

90mm basket strainer waste(s) and pipework supplied

Easy clean bowl curves



Image shows the Acton 1.5 Bowl and Gosford Aquifer in Chrome

Single bowl and drainer
[reversible]



AW1040
White Ceramic



length 1000mm
width 500mm
depth 210mm
bowl 1 capacity 28L
min base unit 600mm

1.5 bowl and drainer
[reversible]



AW1041
White Ceramic



length 1000mm
width 500mm
depth 210mm
bowl 1 capacity 21.5L
min base unit 600mm

Full specification documents can be found at
www.abodedesigns.co.uk

MILFORD

The gentle contours of the Milford are in keeping with its true classic styling to ensure an elegant and traditional finish.

Single bowl and drainer
[reversible]



AW1042
White Ceramic



length 860mm
width 500mm
depth 220mm
bowl 1 capacity 14.44L
min base unit 450mm

1.5 bowl and drainer
[reversible]



AW1043
White Ceramic



length 1000mm
width 500mm
depth 220mm
bowl 1 capacity 13.5L
min base unit 600mm

Durable finest grade fireclay construction throughout

Option of a compact one bowl, designed to complement smaller kitchens or a practical one and a half bowl

Easy clean bowl curves

90mm basket strainer waste(s) and pipework supplied

Free flowing 60mm waste on half bowl of AW1043 for overflow compliance

Full specification documents can be found at www.abodedesigns.co.uk



STAINLESS STEEL INSETS

Abode have designed and manufactured a large collection of stylish 304 grade stainless steel inset sinks with features throughout. Whether you're looking for a flush fit installation, distinctive drainer, large bowl size, top mounted drainer or sleek simplicity, you'll find a solution in this collection.



Image shows the Neron Single Bowl, Althia Single Lever in Chrome and Swich Round in Chrome

CONNEXT

With generous bowl sizing and a distinctive drainer pattern, the Connekt sink family offers practicality as well as contemporary styling.



Image shows the Connekt Single Bowl and Althia Pull Out in Brushed Nickel

Single bowl and drainer
[reversible]



AW5056
Stainless Steel



length 860mm
width 500mm
depth 175mm
bowl 1 capacity 16L
min base unit 450mm

1.5 bowl and drainer
[reversible]



AW5057
Stainless Steel



length 1000mm
width 500mm
depth 195mm
bowl 1 capacity 18.9L
min base unit 600mm

Double bowl and drainer
[reversible]



AW5060
Stainless Steel



length 1160mm
width 500mm
depth 195mm
bowl 1 capacity 18.9L
min base unit 800mm

0.8mm durable 304 grade brushed stainless steel construction

Orbit wastes with easy empty fold-back basket and pipework supplied

The unique two bowl option is ideal for use in the utility room to make those tedious chores that little bit simpler

Unbrushed steel finish

Full specification documents can be found at www.abodedesigns.co.uk

IXIS

Sleek and streamlined, blending contemporary shapes with practical versatility and a distinctive drainer, the Ixis injects both design and flair into any modern kitchen.

Single compact bowl and drainer
[reversible]



AW5101
Stainless Steel



length 860mm
width 500mm
depth 172mm
bowl 1 capacity 16.8L
min base unit 450mm

Single large bowl and drainer
[reversible]



AW5102
Stainless Steel



length 1000mm
width 500mm
depth 180mm
bowl 1 capacity 27.4L
min base unit 600mm

1.5 bowl and drainer
[reversible]



AW5103
Stainless Steel



length 1000mm
width 500mm
depth 173mm
bowl 1 capacity 16.8L
min base unit 600mm

0.8mm durable 304 grade brushed stainless steel construction

Orbit wastes with easy empty fold-back basket and pipework supplied

Brushed steel finish

Full specification documents can be found at
www.abodedesigns.co.uk



Image shows the Ixis 1.5 Bowl and Quantic Monobloc in Chrome



MIKRO

A classically styled sink with a geometric detailed drainer pattern and clean, crisp lines throughout. A wonderfully versatile design that perfectly pairs with an array of Abode mixer taps, injecting both fashion and functionality into either your kitchen or utility.

Single bowl and drainer
[reversible]



AW5062
Stainless Steel

length 860mm
width 500mm
depth 187mm
bowl 1 capacity 13.5L
min base unit 450mm



1.5 bowl and drainer
[reversible]



AW5061
Stainless Steel

length 1000mm
width 500mm
depth 187mm
bowl 1 capacity 13.7L
min base unit 600mm

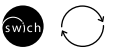

0.7mm durable 304 grade brushed stainless steel construction

90mm basket strainer waste(s) and pipework supplied

Unbrushed steel finish

Full specification documents can be found at www.abodedesigns.co.uk

NERON

A sleek design with linear influences and true practicality at heart. The single bowl designs have a top mounted flush-plate overflow next to the drainer so if the bowl is full you can still pour away drinks if needed. You also have the allowance of optimum bowl filling for cleaning larger items.

0.7mm durable 304 grade brushed stainless steel construction

Orbit wastes with easy empty fold-back basket and pipework supplied

Flush-plate overflow integrated beside the drainer on one bowl options and side mounted in the 1.5 bowl design

High bowl capacity of up to 36.2L

Brushed steel finish



Image shows the Neron Single Bowl, Althia Single Lever in Chrome and Switch Round in Chrome



NERON

Single compact bowl and drainer
[reversible]



AW5111
Stainless Steel



length 860mm
width 500mm
depth 220mm
bowl 1 capacity 27.3L
min base unit 500mm

Large single bowl and drainer
[reversible]



AW5112
Stainless Steel



length 1000mm
width 500mm
depth 219mm
bowl 1 capacity 36.2L
min base unit 600mm

1.5 bowl and drainer
[reversible]



AW5113
Stainless Steel



length 1000mm
width 500mm
depth 218mm
bowl 1 capacity 19.1L
min base unit 600mm

Full specification documents can be found at www.abodedesigns.co.uk

TRYDENT

A simple yet classic design that is contemporary in style yet beautifully timeless. The distinctive drainer pattern, soft angles and unbrushed steel finish allow the Trydent to sit equally as at home in both modern and traditionally styled interiors alike.

Single bowl and drainer
[reversible]



AW5054
Stainless Steel



length 860mm
width 500mm
depth 175mm
bowl 1 capacity 15.1L
min base unit 450mm

1.5 bowl and drainer
[reversible]



AW5055
Stainless Steel



length 1000mm
width 500mm
depth 175mm
bowl 1 capacity 15.1L
min base unit 600mm

0.6mm durable 304 grade brushed stainless steel construction

90mm basket strainer waste(s) and pipework supplied

Distinctive drainer pattern

Unbrushed steel finish

Full specification documents can be found at www.abodedesigns.co.uk



Image shows the Trydent 1.5 Bowl and Nexa Monobloc in Chrome

VERVE

The tight corners and sleek drainer give Verve its premium, contemporary appearance. With its generous deep bowl sizes, this collection of handmade sinks is as practical as it is stylish.

Single bowl and drainer
[reversible]



AW5136
Stainless Steel



length 1000mm
width 530mm
depth 190mm
bowl 1 capacity 24.8L
min base unit 600mm

1.5 bowl and drainer
[reversible]



AW5137
Stainless Steel



length 1000mm
width 530mm
depth 190mm
bowl 1 capacity 19.3L
min base unit 600mm

Durable and resilient 304 stainless steel with 1mm construction

Solid tap deck for sturdy installation of mixer tap

Orbit wastes with easy empty fold-back basket and pipework supplied

90mm waste hole allowing waste disposer installation

Brushed finish



Full specification documents can be found at www.abodedesigns.co.uk





WASTES AND OVERFLOWS (MATT BLACK)

NEW

Stylish, slick, and streamlined. The Abode collection of Matt Black wastes and overflows are perfect for adding a touch of modern-day minimalism to your kitchen. A collection that pairs wonderfully with our Matt Black tap range, blends beautifully with our granite sink range and also provides a sharp, striking contrast with our stainless-steel sinks.

Manual basket
strainer waste



AXI135
Matt Black

Rectangular
overflow



AXI137
Matt Black

Round overflow
pipework



AXI138
Matt Black



Handcrafted in Italy, with a Matt Black through colour, ensures ultimate quality and durability comes as standard

Due to its longer screw, our 90mm waste will fit any sink with the same waste measurement, regardless of thickness

The subtle yet stylish overflows adds a slight industrial touch to your kitchen

Full specification documents can be found at www.abodedesigns.co.uk



WASTES AND OVERFLOWS (ANTIQUE BRASS)

NEW

Timeless, traditional, and sure to take centre stage in your kitchen. Our collection of Antique Brass wastes and overflows will add a little luxury to your kitchen. Matching harmoniously with our Antique Brass tap collection to create a classical look that is sure to last.

Manual basket
strainer waste



AXI136
Antique Brass

Rectangular
overflow



AXI140
Antique Brass

Round overflow
pipework



AXI139
Antique Brass



Handcrafted, oil-rubbed and hand brushed in Italy to ensure ultimate quality and durability comes as standard

Due to its longer screw, our 90mm waste will fit any sink with the same waste measurement, regardless of thickness

The rectangular overflow is the perfect blend either modern and traditional or classic and contemporary to add depth to any kitchen scheme with paired tap and waste

Full specification documents can be found at www.abodedesigns.co.uk



Taps



CONTENTS

Steaming Hot Water Taps	104
Industrial Style Taps	148
Contemporary:	
Single Lever Taps	170
Monobloc Taps	194
Pull Out & Professional Taps	222
Stainless Steel Taps	250
Traditional Taps	262
Water Filter Taps	298
Swich	314
Tap Accessories	318

Scan to view
Kitchen Taps
Price List



Style & finishes

A completely unique range of designs shaped by our UK design team. From contemporary single levers and functional steaming hot water taps to traditional monoblocs in a variety of finishes, we have an extensive range to ensure we have the perfect high quality design for every kitchen.

Design, quality and innovation are at the heart of what we do.

Finding a tap that not only matches, but perfectly complements your kitchen and all of the accessories within it can be challenging. That's why we are constantly updating our portfolio, as well as adding new finishes to the mix to ensure the perfect finishing touch every time.



Steaming Hot Water Taps



Water Filter Taps

Stainless Steel



Industrial



Traditional

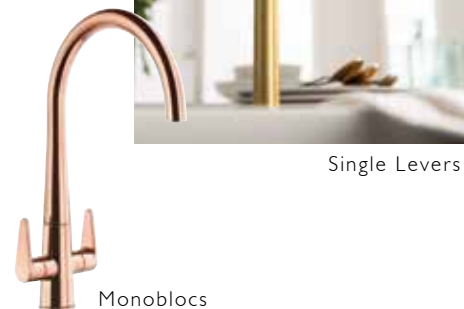

Single Levers

Monoblocs

Pull Outs and Professional

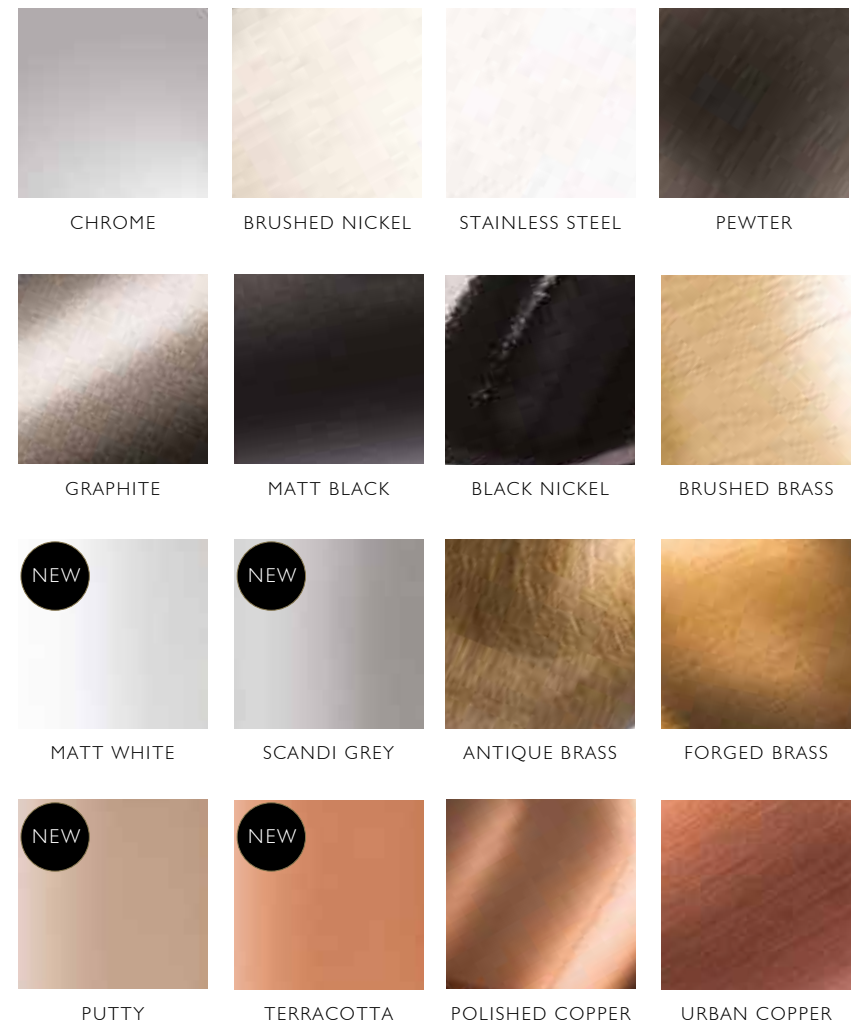

Tap performance

To ensure you achieve the best possible performance from your chosen tap, you need to be able to identify the existing plumbing system in place and therefore estimate the water pressure.

The following information provides a general overview on water pressure, however we do recommend that a plumber checks your water pressure with a pressure gauge.

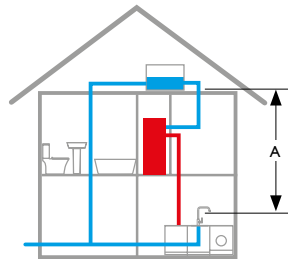

Lower Pressure (gravity fed / vented system)

You have a cold water tank in the loft space and a hot water tank in the airing cupboard

You don't have an additional pump which is activated when you turn on any hot tap

The amount of hot water available to you is limited

With a gravity fed system you can approximate your hot water pressure by dividing the vertical distance (A) in metres by 10 (e.g. 3m = 0.3 Bar)

You should choose taps which are suitable for use with a lower pressure system

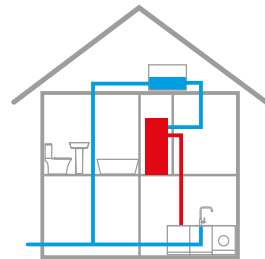

High Pressure (pumped gravity fed system)

You have a cold water tank in the loft and a hot water cylinder in the airing cupboard

You have an additional pump (normally located near the hot water cylinder) which is automatically activated when you turn on any hot tap

The pressure is defined by the pump. See pump manufacturer's details.

You should be free to choose from most of our tap range

The amount of hot water available is limited

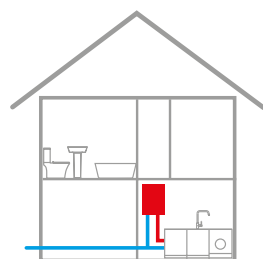

High Pressure (combi boiler)

You have a boiler but no separate hot water storage cylinder

The boiler is typically found in the kitchen

Hot water is delivered instantly and on demand

This system is typically delivers the hot water between 1 and 1.5 bar

You should be free to choose from most of our tap range

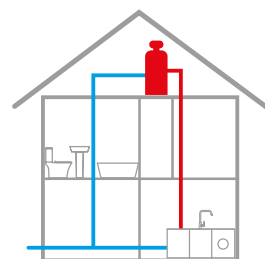

High Pressure (unventilated system)

Most commonly referred to as a "Megaflo" or similar brand

You have a hot water cylinder directly connected to the cold water supply. Above the cylinder could be an expansion vessel. (The hot water cylinder is typically in the loft space)

You do not have a cold water tank

The hot and cold water pressure is typically around 3 bar

The amount of hot water available is limited

You should be free to choose from any of our taps



WATER AERATION

All mixers use spout aerators or flow straighteners to add bubbles to the water. These innovations in fluid technology keep your water flow in a controlled and distinctive pattern and eliminates splash back.

VALVE CARTRIDGES

Abode use ceramic disc valves in all of our tap designs. These are tested for over 200,000 cycles before we will pass them for use within our taps. Why? Well this means that under normal use conditions your tap valves have proven that they will work for many years to come. The kitchen tap is the most used appliance in the kitchen, so valve quality assurance is essential.

TESTING

Abode products are designed specifically for the UK by our team of in-house designers. We use artisan hand polishing techniques, sophisticated plating and powder coating processes to ensure a blemish free surface, along with robotic production of parts for precision. Every Abode product is 100% end of line tested before it leaves the factory, giving you absolute peace of mind.

EVERYTHING IN ONE BOX

After taking all this care with the product, we want to ensure they reach you in perfect condition with all the parts that you will need for a seamless and straightforward installation. Fixing kits and tail pipes (with non return valves where necessary) are provided. If the tap is heavy or tall, we also provide you with a tap stabilisation bracket in the box. We try and think of everything so you don't have to.

Throughout this section you will see the following symbols next to products where relevant:



PRONTEAU™
by abode

STEAMING HOT WATER TAPS

Useful technology is fast becoming the norm in the modern kitchen, with hot water taps being firmly among their number. Many of us increasingly look for additional functionality from the kitchen tap as we would from an appliance. Steaming hot water taps fulfill a need and we'll put your mind at ease about any safety concerns across the following pages, a steaming hot water tap is safer than a kettle in many ways.

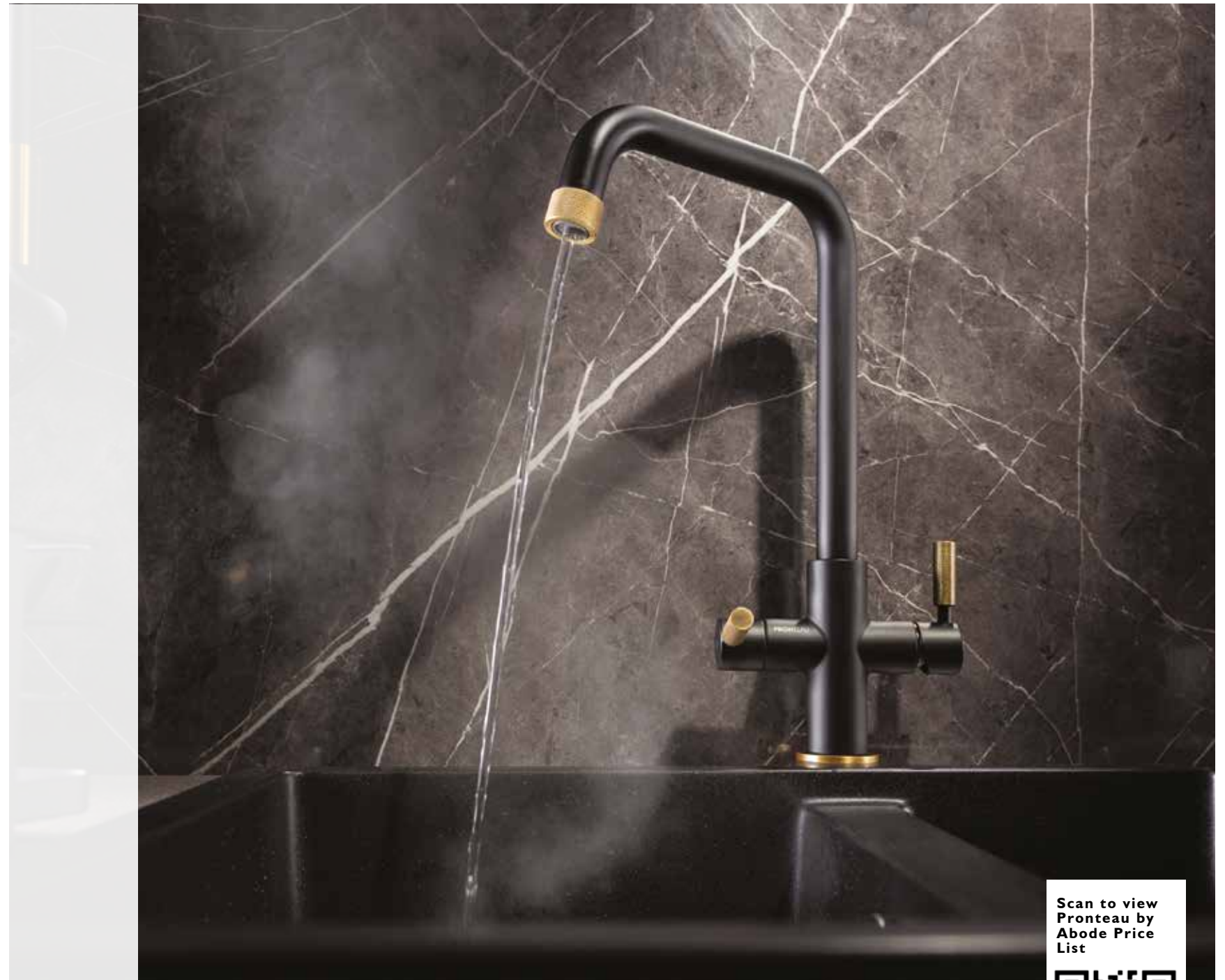

Scan to view
Pronteau by
Abode Price
List



Why should I choose a

PRONTEAUTM
by abode

Steaming Hot Water Tap?



1/ SAVE TIME

Adding a Pronteau to the kitchen is guaranteed to make a difference and leave you thinking how you got by without a steaming hot water tap.

Some of the benefits to note are;

- Instant hot drinks
- Speed up cooking tasks such as pan filling for vegetables, pasta or rice cooking
- Instant porridge or noodles
- Speeding up cleaning tasks such as pan and dish rinsing

2/ DO YOUR BIT FOR THE ENVIRONMENT



By switching to filtered water from the tap in comparison to buying bottled mineral water you will save money as well as aiding the reduction of plastic waste.

Our 4 IN 1 ranges have it all, domestic hot & cold water, filtered steaming hot water and filtered cold water.

All Pronteau filters are part of a **FREE filter recycle scheme**.



3/ STREAMLINE THE KITCHEN

Free up worktop and fridge space of kettles and filter jugs for clutter-free worktops and that extra fridge space that we often find ourselves needing.

4/ SERVICE ON HAND

We have an in-house Pronteau specialist service team and engineer fleet on the road.



5/ REDUCE WATER WASTAGE

As there is no need to fill the kettle every time a hot drink is made or a pan is to be filled, you will find that water and energy wastage in the household is reduced.

6/ IMPROVE THE TASTE OF HOT DRINKS WHILST PROTECTING YOUR BOILER

All Pronteau products are supplied with a filter. This filter has an important role as it maintains the long-term health of your boiler, preventing excessive limescale build up.

Secondly, achieve great tasting hot drinks every time as the filter will improve the taste of your water and prevent the scum that you sometimes find on hot drinks.



8/ COMPACT BOILER SIZE

Our boilers pack in functionality but remain compact in size, so much so that they fit in a Belfast cabinet with ease.



7/ NEVER WORRY ABOUT SAFETY

Our products have been designed with safety in-mind. Our patented HotKey® range is considered by many as the safest hot tap option as the HotKey® can be stored out of reach of children when not in use. The ProBoil.2X collection have a two-stage handle to dispense the steaming hot water, push the handle down or slide it across and turn the handle to safely dispense the water.

Choosing the right Hot Water Tap for you

THE PRONTEAU RANGE IS LIMITLESS. ACROSS THE COLLECTION WE OFFER A WIDE RANGE OF STYLES AND FINISHES TO MEET YOUR DESIGN EXPECTATIONS WITH THE ADDED BENEFIT OF STEAMING HOT WATER ON TAP.



FUNCTIONS

3 IN 1

domestic cold, domestic hot and filtered steaming hot water

4 IN 1

domestic cold, domestic hot, filtered cold and filtered steaming hot water

Why
98 degrees?

When we developed our innovative range of steaming hot water taps for launch in 2016 we took into consideration every aspect of safety, not only for the dispensing of the steaming hot water but also the maximum temperature requirements for the stored water in the boiler. This is the main reason our products store water to a maximum temperature of 98°C, this makes our product fully compliant with Part G(3) of the UK Building Regulations, and all Pronteau taps, boilers and filters are WRAS approved or WRAS pending.



STYLE

A variety of models, styles, popular finishes and boiler sizes allow you to tailor your experience of Pronteau hot water taps to ensure you get the right model for your household.

We have most recently launched our Slimline Prothia 3 IN 1 hot taps that will look perfect in every home. Not only that, our latest 4 IN 1 mechanical range, Propure offer hot and cold domestic supply along with filtered steaming hot and filtered cold drinking water.

Professional style

Available in the 3 IN 1 range. The steaming hot water is dispensed from an outlet in the crossbar. Also features a pull around with spray function for the domestic hot and cold supply.



PRONTEAU™
by obode

3 IN 1 with **PROBOIL.2X**

3 IN 1 functionality delivering; domestic hot, domestic cold and steaming hot filtered water

Dual stage water operation safety - the handles of all taps incorporate safety devices to limit use

Supplied with the compact ProBoil.2X boiler with a 2.1 litre capacity

All Pronteau taps have cool touch spouts thanks to a centrally insulated steaming water channel

Supplied with multistage filtration to address scale formation in the boiler, remove contaminants, and improve taste & odour of the steaming hot water to achieve the perfect hot drink

The supplied filter part of the Abode filter recycle scheme



TAPS

HOT WATER TAPS \ 3 IN 1 \ 111

Image shows the Industria Monobloc in Brushed Nickel



PRONTEAU™
by **abode**

3 IN 1 with **PROBOIL.2X**

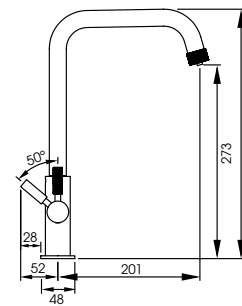

NEW

Industria
Monobloc

PT1196
Brushed Nickel

1.5 cold
0.75 hot
180°

Overflowing with both industrial inspiration, British design and leading engineering, the Abode Industria is here to revolutionise your kitchen.

Adorned with distinctive, diamond knurled detailing that features on the spout and handles, making it truly unique and exquisite.

Features a two-stage safety handle, simply push the left handle down and pull forward to release the steaming hot water, whenever it's needed.

Easy to change, easy to fit, high quality carbon and resin scale filter & installation pack included that's also part of the filter recycle scheme.



PT1197
Matt Black / Antique Brass

Full specification documents can be found at www.pronteau.co.uk

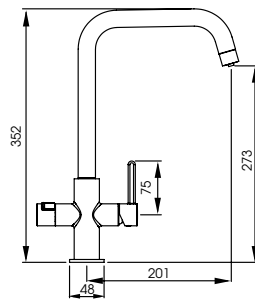

Prothia
Quad Spout

PT1140
Chrome



The Prothia features a stylish, single side lever, blends square and round lines and a quad spout to create a sleek design with a modern edge, with the additional functionality of steaming hot water delivered safely through our cool touch spout.

This slimline 3 IN 1 tap is currently the slimmest of its kind in the market.



The steaming hot water is operated by the two stage handle lock on the left. This must be pushed left and held whilst turning the handle back to safely dispense the steaming hot water.



PT1141
Brushed Nickel



PT1142
Matt Black



PT1143
Brushed Brass



PT1144
Urban Copper

Full specifications are available at www.pronteau.co.uk



Scan to view
video showing
the Prothia
in action on
our YouTube
channel.



Image shows the Prothia 3 IN 1 Slimline Mixertap with Quad Spout in Brushed Brass

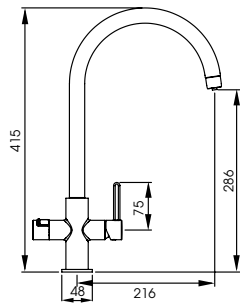

Prothia
Swan Spout

PT1130
Chrome



more Style: Contemporary slimline aesthetic

more Choice: 5 finishes and 2 designs

more Control: Digital boiler interface with filter change indication

more Simplicity: Simple colour coded toolless installation and commissioning

more Safety: Dual stage safety handle for peace of mind



Two stage
handle lock



PT1131
Brushed Nickel



PT1132
Matt Black



PT1133
Brushed Brass



PT1134
Urban Copper

Full specifications are available at www.pronteau.co.uk



Scan to view
video showing
the Prothia
in action on
our YouTube
channel.



Image shows the Prothia 3 IN 1 Slimline Mixertap with Swan Spout in Chrome

ProTrad
3 IN 1

CLASSIC STYLE
meets
MODERN FUNCTION



PRONTEAUTM
by *abode*

3 IN 1 with **PROBOIL.2X**

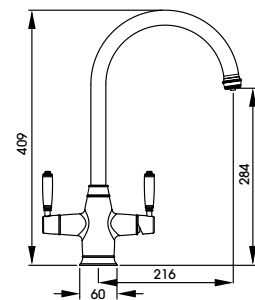

Protrad
Monobloc

PT1190
Chrome



The perfect pairing for an Abode ceramic sink. Our compact PROBOIL.2X boiler sits neatly in a Belfast cabinet.

Pairing timeless, British style with the latest engineering to give you instant access to steaming hot water at the twist of a handle - The ProTrad is a true modern day classic!

Steaming hot water is dispensed via a two stage handle operation, push the left handle down and pull forward to release the steaming hot water.

Each tap is supplied with the temperature controllable, 2L PROBOIL.2X boiler and paired filter to protect your boiler and deliver the perfect hot drink.



PT1191
Brushed Nickel



PT1192
Antique Brass

Full specification documents can be found at www.pronteau.co.uk

TAPS
HOT WATER TAPS \ 3 IN | 119

PRONTEAU[™]
by **abode**

3 IN 1 with **PROBOIL.2X**

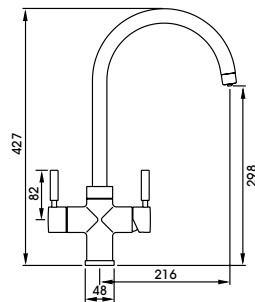

Prostream
Monobloc

PT1101
Chrome



The Prostream feature clean curves, perfectly balanced proportions and packed with the latest engineering technology to create a tap that is stylish, steaming and safe.

Supplied with the PROBOIL.2X boiler and recyclable PROBOIL filter.



PT1102
Brushed Nickel



PT1103
Graphite



PT1104
Matt Black



PT1105
Urban Copper



TAPS

HOT WATER TAPS \ 3 IN 1 \ 121

Image shows the Prostream 3 IN 1 Monobloc in Urban Copper

PRONTEAU[™]
by **abode**

3 IN 1 with **PROBOIL.2X**

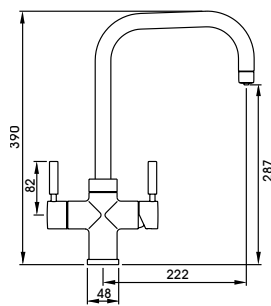

Prostyle
Monobloc

PT1111
Chrome



The Prostream features dynamic, dual lever styling, a minimal and modernist contoured spout and packed with the latest engineering to create a tap that is always stylish, steaming and safe.

Supplied with the PROBOIL.2X boiler and recyclable PROBOIL filter.



PT1112
Brushed Nickel



PT1113
Graphite



PT1114
Matt Black



PT1115
Urban Copper



TAPS

HOT WATER TAPS \ 3 IN 1 | 123

PRONTEAU[™]
by **abode**

3 IN 1 with **PROBOIL.2X**



Professional
Monobloc

PT1122
Chrome

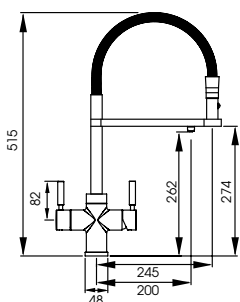

3 IN 1 functionality delivering; domestic hot, domestic cold and steaming hot, filtered water

Pull around functionality with spray feature for domestic hot and cold

Dedicated steaming hot water outlet on tap crossbar

Safety 2 stage hot water operation

Energy saving cold Start valve technology

360° cool touch spout thanks to centrally insulated steaming water channel



PT1123
Brushed Nickel

Full specifications are available at www.pronteau.co.uk



TAPS

HOT WATER TAPS \ 3 IN 1 \ 125

Image shows the Professional 3 IN 1 Monobloc in Chrome

PRONTEAU[™]
by obode

4 IN 1 with **PROBOIL.2X**

4 IN 1 functionality delivering; domestic hot, domestic cold and steaming hot, filtered cold water

Dual stage water operation safety - the handles of all taps incorporate safety devices to limit use

Supplied with the new ProBoil.2X boiler with a 2.1 litre capacity

All Pronteau taps have cool touch spouts thanks to centrally insulated steaming water channel

Supplied with multistage filtration to address scale formation in the boiler, remove contaminants, and improve taste & odour of the steaming hot water to achieve the perfect hot drink

The supplied filter is fully recyclable by Abode



Download a copy of the Pronteau brochure at www.pronteau.co.uk



ProTrad
4 IN 1

CLASSIC STYLE
meets
MODERN FUNCTION



PRONTEAU™
by *abode* 4 IN 1 with **PROBOIL.2X**

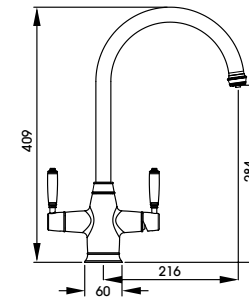

Protrad
Monobloc

PT1193
Chrome



The perfect pairing for an Abode ceramic sink. Our compact PROBOIL.2X boiler sits neatly in a Belfast cabinet.

Pairing timeless, British style with the latest engineering to give you instant access to steaming hot water at the twist of a handle - The ProTrad is a true modern day classic!

Steaming hot water is dispensed via a two stage handle operation, push the left handle down and pull forward to release the steaming hot water.

Each tap is supplied with the temperature controllable, 2L PROBOIL.2X boiler and paired filter to protect your boiler and deliver the perfect hot drink.



PT1194
Brushed Nickel



PT1195
Antique Brass

Full specification documents can be found at www.pronteau.co.uk

Propure Monobloc
Quad Spout

PT1160
Chrome

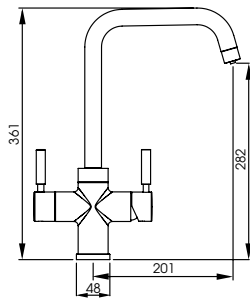

On top of hot & cold domestic water and 98°steaming hot water on demand, Propure offers a more sustainable way of living with the supply of fresh filtered water meaning you can make a start to ditch the use of single use plastic in the home.

Based on our award winning Prostream and Prostyle design series, water is delivered safely through our cool touch spout.



PT1161
Brushed Nickel



PT1162
Matt Black



PT1163
Brushed Brass



PT1164
Urban Copper



Scan to view
video showing
the Propure
in action on
our YouTube
channel.

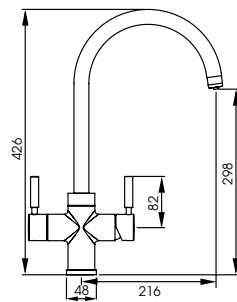

Image shows the Propure 4 IN 1 Monobloc in Brushed Brass



Propure Monobloc
Swan Spout

PT1150
Chrome



more Style: Contemporary aesthetic

more Choice: 5 finishes and 2 designs

more Control: Digital boiler interface with filter change indication

more Simplicity: Simple colour coded toolless installation and commissioning

more Safety: Dual stage safety handle for peace of mind



PT1151
Brushed Nickel



PT1152
Matt Black



PT1153
Brushed Brass



PT1154
Urban Copper



Scan to view
video showing
the Propure
in action on
our YouTube
channel.



Image shows the Propure 4 IN 1 Monobloc in Brushed Brass

PRONTEAU™
by obode

4 IN 1 with **PROBOIL.4E**

A range of monobloc and 3 part instant hot water taps, in an array of on trend finishes

All taps have 4 IN 1 functionality; domestic hot & cold, instant steaming hot and filtered cold water

Products feature a patented design, the steaming hot water is dispensed using our exclusive HotKey® - possibly the safest way to dispense instant hot water

All products are supplied with the NEW PROBOIL.4E, an exclusive 4L boiler design

All taps are supplied with the premium water optimisation filter. Part of the Abode filter recycle scheme



Download a copy of the Pronteau brochure at www.pronteau.co.uk





PRONTEAU™
by **abode**

4 IN 1 with **PROBOIL.4E**

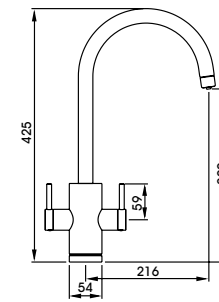

Profile
Monobloc

PT1001-2
Chrome



Featuring patented HotKey® technology. The instant steaming hot water is dispensed only when the HotKey is placed against the tap body, optimising safety and making this the ideal option for anyone with dexterity problems or similar.

Sleek swan spout is perfect for traditional and contemporary kitchens alike.

4 IN 1 functionality; domestic hot & cold, instant steaming hot and filtered cold water.

Supplied with the NEW PROBOIL.4E boiler and premium water optimisation filter.



PT1002-2
Brushed Nickel



PT1026-2
Matt Black



PT1051
Antique Brass

Full specification documents can be found at www.pronteau.co.uk



PRONTEAU™
by obode

4 IN 1 with **PROBOIL.4E**

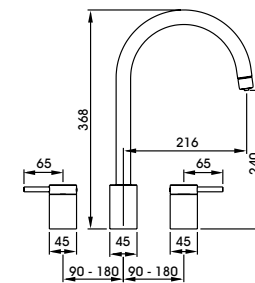

Profile
3 Part Mixertap

PT1007-2
Chrome



Featuring patented HotKey® technology. The instant steaming hot water is dispensed only when the HotKey is placed against the tap body, optimising safety and making this the ideal option for anyone with dexterity problems or similar.

Unique 3 Part design. Achieve a premium, truly traditional finish with all the functionality you need on tap.

4 IN 1 functionality; domestic hot & cold, instant steaming hot and filtered cold water.

Supplied with the NEW PROBOIL.4E boiler and premium water optimisation filter.



PT1008-2
Brushed Nickel



PT1053
Antique Brass

Full specification documents can be found at www.pronteau.co.uk

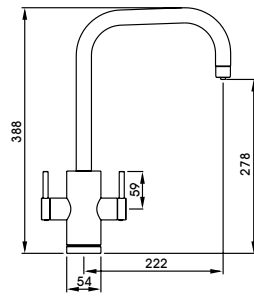

Project
Monobloc

PT1003-2
Chrome



Featuring patented HotKey® technology. The instant steaming hot water is dispensed only when the HotKey is placed against the tap body, optimising safety and making this the ideal option for anyone with dexterity problems or similar.

Stylish quad spout makes this the perfect option for contemporary kitchens.

4 IN 1 functionality; domestic hot & cold, instant steaming hot and filtered cold water.

Supplied with the NEW PROBOIL.4E boiler and premium water optimisation filter.



PT1004-2
Brushed Nickel



PT1027-2
Matt Black



PT1052
Brushed Brass



Project
3 Part Mixertap

PT1009-2
Chrome



Featuring patented HotKey® technology. The instant steaming hot water is dispensed only when the HotKey is placed against the tap body, optimising safety and making this the ideal option for anyone with dexterity problems or similar.

Unique 3 Part design. Achieve a premium, contemporary finish with all the functionality you need on tap.

4 IN 1 functionality; domestic hot & cold, instant steaming hot and filtered cold water.

Supplied with the NEW PROBOIL.4E boiler and premium water optimisation filter.



PT1010-2
Brushed Nickel

PT1054
Matt Black



Image shows the Project 3 Part Mixertap in Matt Black

PRONTEAU[™]
by obode

4 IN 1 with **PROBOIL.4E**

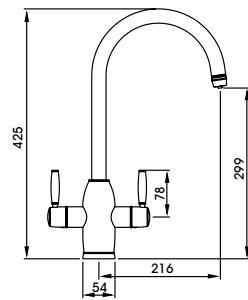

Province
Monobloc

PT1005-2
Chrome



Featuring patented HotKey® technology. The instant steaming hot water is dispensed only when the HotKey is placed against the tap body, optimising safety and making this the ideal option for anyone with dexterity problems or similar.

Traditional design with slender body and ceramic style handles.

4 IN 1 functionality; domestic hot & cold, instant steaming hot and filtered cold water.

Supplied with the NEW PROBOIL.4E boiler and premium water optimisation filter.



PT1006-2
Brushed Nickel



PT1019-2
Antique Brass



Full specifications are available at www.pronteau.co.uk



TAPS

HOT WATER TAPS \ 3 IN | 145

Image shows the Province Monobloc in Antique Brass

The Boilers



PROBOIL.2X

All two-stage Pronteau taps across pages 104 to 125 include the Proboil.2X boiler which has a 2L tank capacity.

All Pronteau HotKey® taps across pages 134 to 145 include the Proboil.4E boiler which has a 4L tank capacity.

Both boilers have the following features:

Controllable temperature range which can be set between 75 & 98° via the on screen digital controls

Compact stainless steel tank which fits beneath a Belfast or Butler sink

Simple to install via colour coded connectors

Filter life indicator

WRAS approved



NATIONAL TEAM OF OVER 30 SERVICE ENGINEERS ACROSS THE UK SHOULD YOU NEED US



All Pronteau boilers are protected by our Proboil filters (supplied with all system product purchases). These filters are essential to ensure protection of your boiler from scale build up as well as reducing water hardness out of the tap to improve taste and clarity of hot drinks.



PROBOIL.4E

Scan to view all Pronteau videos on our YouTube channel.



Please visit www.pronteau.co.uk for more information on Proboil maintenance.

INDUSTRIAL STYLE TAPS

Add soft industrial touches and texture to your kitchen design with the Hex and Fraction families. Our industrial taps offer will coordinate effortlessly with any kitchen featuring industrial style elements or add interest and edge to a kitchen design featuring traditional elements.

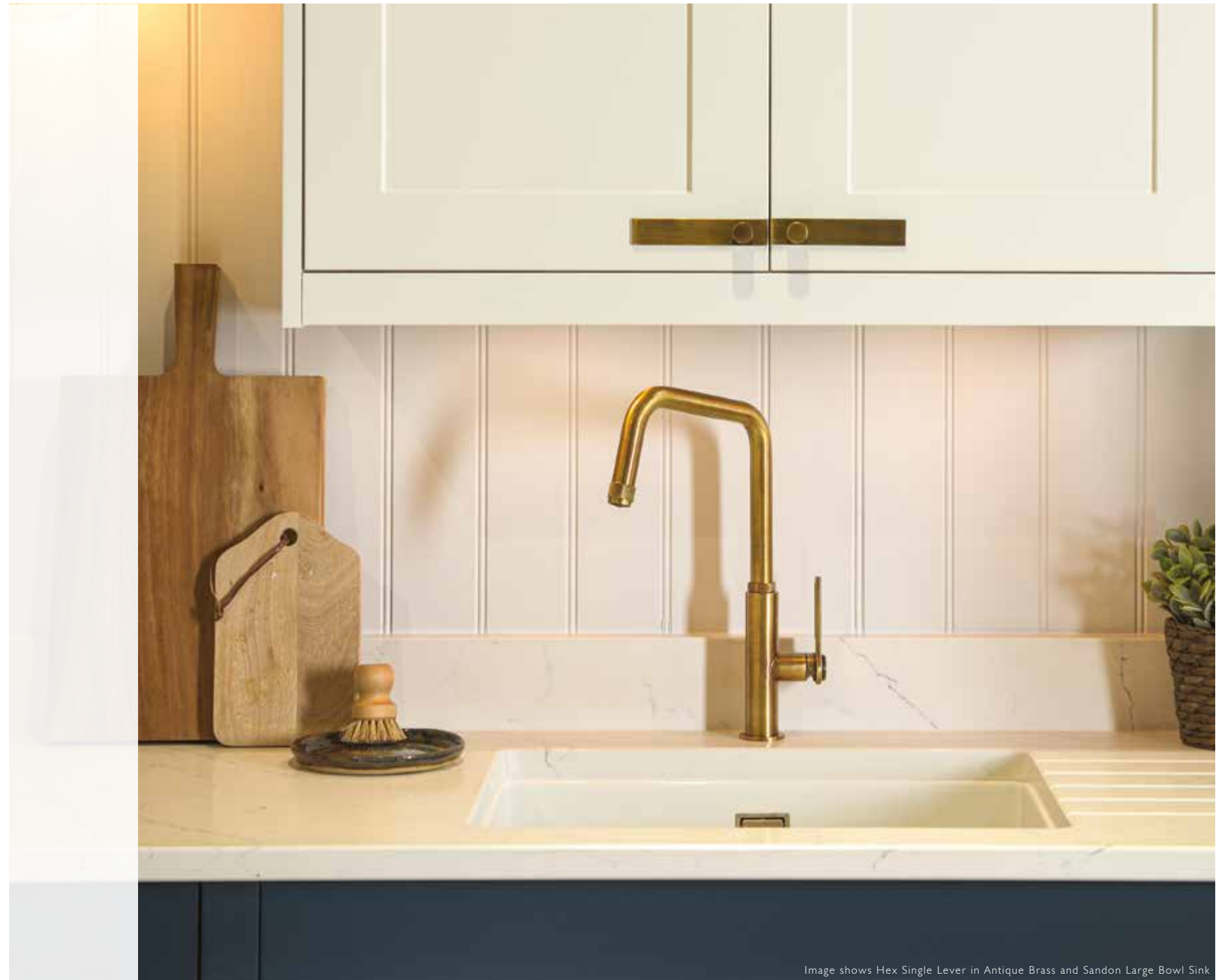

Image shows Hex Single Lever in Antique Brass and Sandon Large Bowl Sink



/ THE INDUSTRIAL TREND

CONTINUES TO THRIVE!

We have extended our award winning Hex range by adding a Matt Black finish with brass accents on the spout, handle(s), collar and base plinth to the single lever, dual lever and pull out Hex collections.

Designed to challenge traditional concepts and make the ultimate statement, with distinctive features, the Hex range will coordinate effortlessly with any kitchen featuring industrial style elements and also add interest and edge to a kitchen design featuring traditional elements.

We have strengthened our industrial taps offer further by adding the Fraction collection. A unique L-spout design with cog style detailing on the handle to give a more subtle industrial injection. This collection includes; a single lever, pull out and professional option.

Choose from an array of finishes across this collection for the perfect finishing touch.





Image shows the Sandon Large Single Bowl and HEX Single Lever in Antique Brass

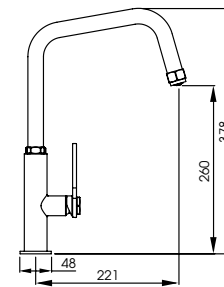

HEX
Single Lever

AT2085
Brushed Nickel



Premium quality brass construction

Striking industrial chic design with hexagonal features on the handle & tip and base of the spout

Energy efficient cold start function

Hidden cache aerator



AT2086
Matt Black



AT2087
Antique Brass



AT2180
Matt Black / Antique Brass

Full specification documents can be found at www.abodedesigns.co.uk

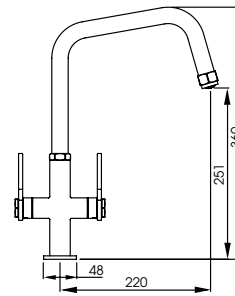

HEX
Monobloc

AT2091
Brushed Nickel



Premium quality solid brass construction

Striking industrial chic design with hexagonal features on the handle & tip and base of the spout

Industrial styled hot and cold lettering on the handles



AT2092
Matt Black



AT2093
Antique Brass



AT2179
Matt Black / Antique Brass

Full specification documents can be found at www.abodedesigns.co.uk

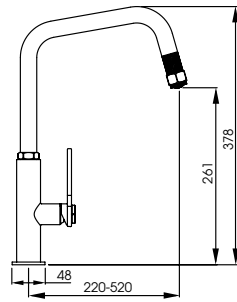

HEX
Single Lever Pull Out

AT2088
Brushed Nickel



Premium quality brass construction

Striking industrial chic design with hexagonal features and cross hatched knurling detail on the tip of the spout

Pull out hose for additional functionality (no spray function)

Energy efficient cold start function



AT2089
Matt Black



AT2090
Antique Brass



AT2181
Matt Black / Antique Brass

Full specification documents can be found at www.abodedesigns.co.uk



Image shows the Studio Compact and HEX Single Lever Pull Out in Brushed Nickel

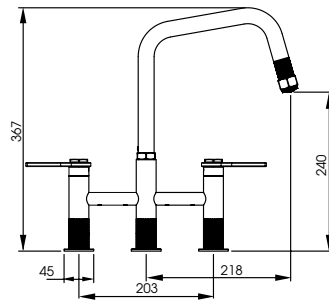

HEX
Bridge Pull Out

AT2198
Brushed Nickel



Features smooth-flex pull out functionality with 60cm reach

Diamond knurled detail adorns the spout end and legs

Prominent hexagonal nut inspired details on the handles and spout

Coordinates effortlessly with contemporary and traditional settings alike



AT299
Antique Brass

Full specification documents can be found at www.abodedesigns.co.uk



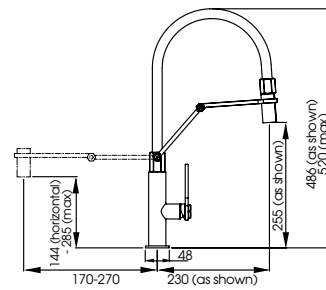

HEX Professional
with spray

AT2094
Brushed Nickel



- Premium quality solid brass construction
- Striking industrial chic design with pivoting mechanical style arm
- Contrasting, durable silicone hose cover
- Pull-around hose with spray feature
- Energy efficient cold start function
- Height adjustable via the central arm and rotating spout capability



Full specification documents can be found at www.abodedesigns.co.uk



Image shows the Fraction Single Lever in Matt Black

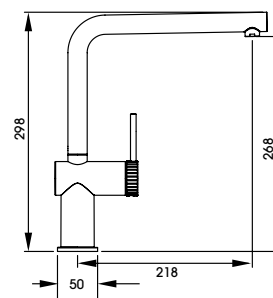

Fraction
Single Lever

AT2152
Chrome



The 90-degree angled spout provides sharp yet sophisticated style

Elongated, slim single lever handle for ultimate ease of use

Industrial cog style handle with discreet hot and cold indicators

Available in four finishes, get the perfect finishing touch every time



AT2153
Brushed Nickel



AT2155
Matt Black



AT2154
Antique Brass

Full specification documents can be found at www.abodedesigns.co.uk

Fraction
Pull Out

AT2156
Chrome

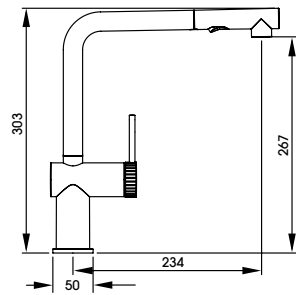

Industrial style with the added functionality of a pull-out spray feature

Neatly hidden, you get the same chic look of the Fraction single lever with the benefit of a spray function. So useful for cleaning tasks

Available in four finishes

Simple and stylish spray button,
in-keeping with this sleek tap design.



AT2157
Brushed Nickel



AT2159
Matt Black



AT2158
Antique Brass

Full specification documents can be
found at www.abodedesigns.co.uk

abode



Image shows the Fraction Pull Out in Matt Black



Image shows the Fraction Semi Professional in Chrome

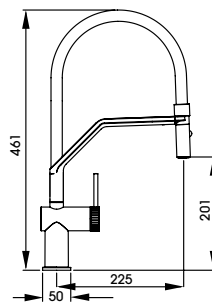

Fraction
Semi Professional

AT2160
Chrome



A style statement. The contrasting elements of this tap perfectly compliment one another

Features a pull around spray function with magnetic self-locating body and head assembly

Available in a chrome or brushed finish with contrasting black crossbar and silicone hose for a truly industrial feel



AT2161
Brushed Nickel

Full specification documents can be found at www.abodedesigns.co.uk

CONTEMPORARY TAPS

Contemporary taps can be defined by several characteristics; sleek lines, stark shapes, distinctive spout styling, the latest finishes and more. The carefully thought out selection of styles available across our range ensures there is a style to suit every environment.

Complement your kitchen design with the latest finishes to add a showstopping feature tap.



Image shows the Agilis Single Lever in Brushed Brass

SINGLE LEVERS

With a variety of benefits, the single lever tap is a popular choice for many, so water wastage is minimised whilst the flow gets to the right temperature. The temperature is easy to adjust with a flick of the wrist and several sleek and streamlined designs, including top lever styles are available.





Scan to view
the Agilis
video on our
YouTube
channel.



Image shows the Agilis Single Lever in Black & Brass

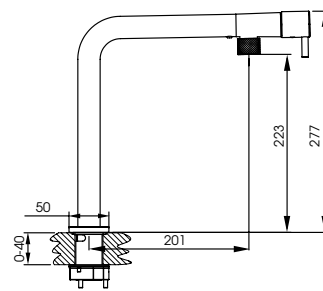

Agilis
Single Lever

AT2184
Chrome



With innovative upfront control, Agilis makes for improved practicality and ease of use.
Distinctly Agile

Flick on /off with swipe of the hand – ideal for limiting touch when hands are dirty

Upfront controls makes reaching the handle easier

On trend colourways with minimalist styling, distinctly different to any other Abode tap

Knurled detail at aerator casing providing a touch of industrial styling

Neoperl Aerator for reduced splashing and water consumption



AT2185
Brushed Nickel



AT2186
Matt Black



AT2187
Black & Brass



AT2188
Brushed Brass

Full specification documents can be found at www.abodedesigns.co.uk



Image shows the Coniq R Single Lever in Brushed Nickel

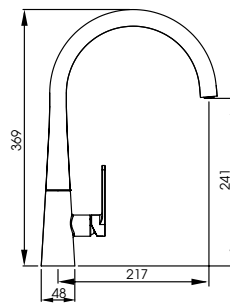

Coniq R

AT2115
Chrome



Stylish and contemporary conical style utilising advanced hydroforming manufacturing techniques

Smooth, rotating swan necked spout, with integrated aeration hidden from view

Four hardwearing finishes available, including the durable and striking matt black and polished copper finishes



AT2116
Brushed Nickel



AT2117
Matt Black



AT2118
Polished Copper

Full specification documents can be found at www.abodedesigns.co.uk

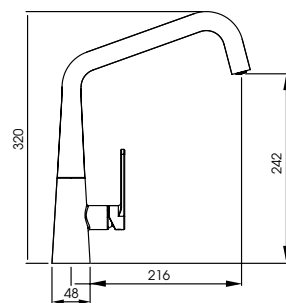

Coniq S

AT2113
Black Nickel



abode
distinctly

Strong, bold and brave styling epitomises this design

Using the latest manufacturing techniques, this model integrates a hidden cache aerator into the functional and modern spout design

Available in two luxury finishes – Polished Copper and Black Nickel, offering a mirrored Chrome effect to match plug points and sockets



AT2114
Polished Copper

Full specification documents can be found at www.abodedesigns.co.uk

Tubist

AT2127

Brushed Nickel



abode
distinctly

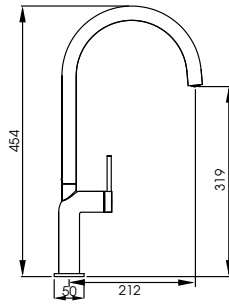

Modern European styling lends everything to the curvaceous and organic form of the Tubist

Using cold start valve technology, the environmentally friendly design will help save heat and wasted energy

Three finishes available: Brushed Nickel, Matt Black & Polished Copper



AT2128
Matt Black



AT2129
Polished Copper



Image shows the Tubist Single Lever in Matt Black

Atlas
Single Lever

AT1092
Chrome

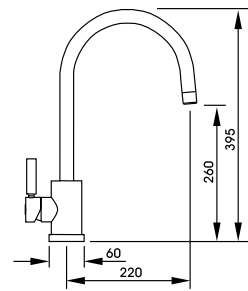
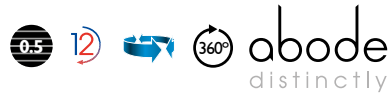

Metal construction throughout. You can feel the quality of the Atlas family of products

Single lever for effortless single-handed control

Four finishes available, the Atlas single lever family will fit seamlessly in any kitchen design



AT1093
Brushed Nickel



AT2101
Matt Black



AT2102
Brushed Brass

Full specification documents can be found at www.abodedesigns.co.uk

abode

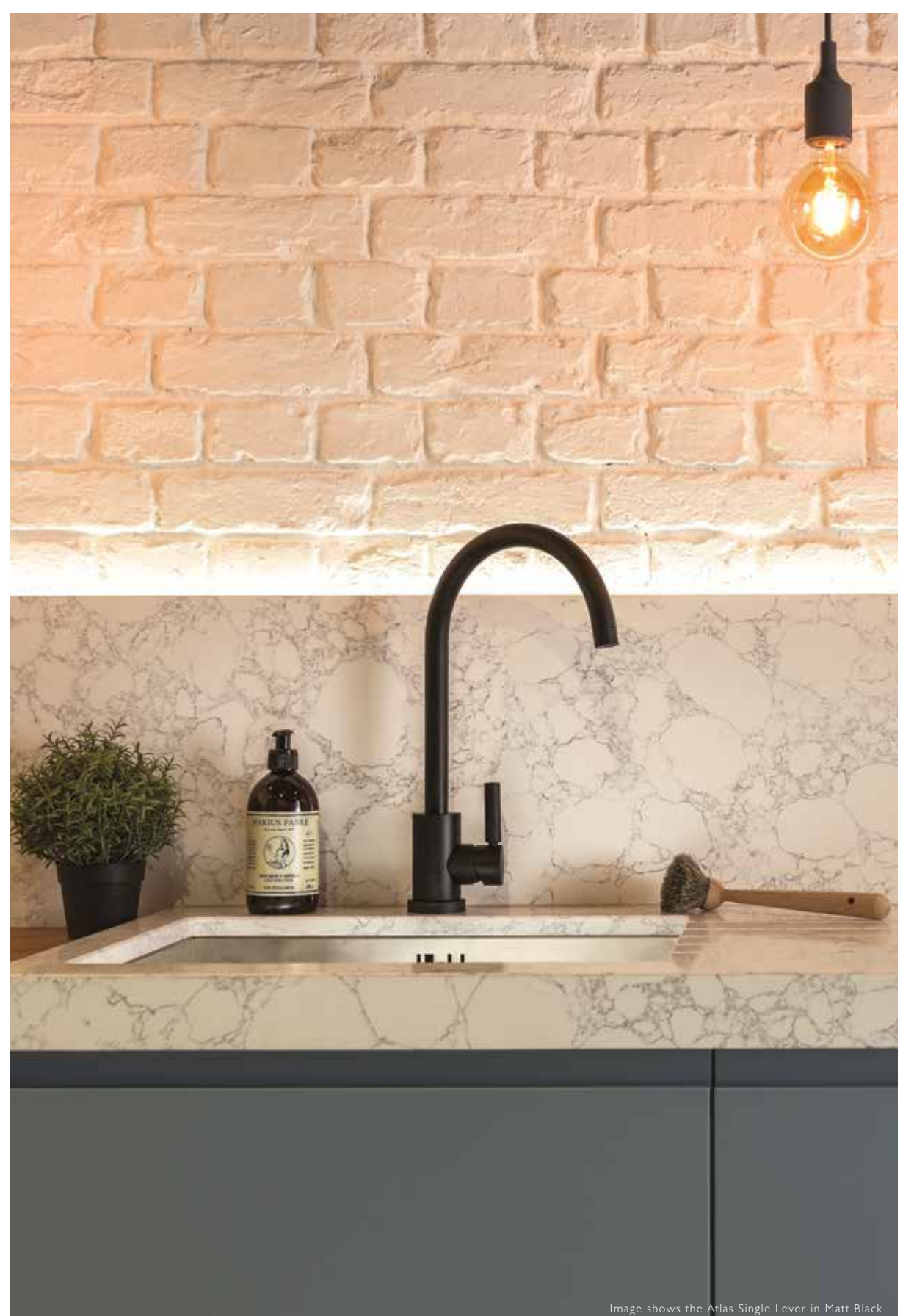
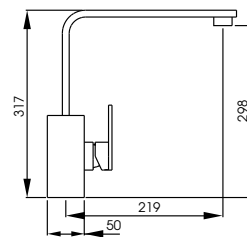

Image shows the Atlas Single Lever in Matt Black



Image shows the New Media Single Lever in Matt Black



New Media
Single Lever

AT1181
Brushed Nickel



Bold and contemporary styling

Smooth, rotating flat planed spout with large square base and minimalist handle design

Three finishes available, including the durable and striking, powder coated matt black finish



AT1180
Chrome



AT1182
Matt Black



Prime
Single Lever

AT1254
Chrome

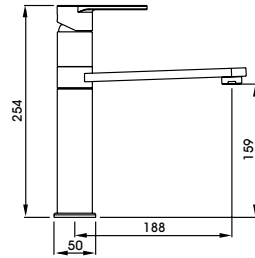

Modern European styling lends to the curvaceous and organic form of the Prime

Unique handle for complete ease of use and control of the water flow and temperature

Three finishes available;
chrome, brushed nickel and the new matt black finish



Subtle
Chrome
detailing



AT1255
Brushed Nickel



AT2104
Matt Black

Full specification documents can be found at www.abodedesigns.co.uk



Image shows the Denton and Prime Single Lever in Matt Black

Althia
Single Lever

AT1258
Chrome



abode

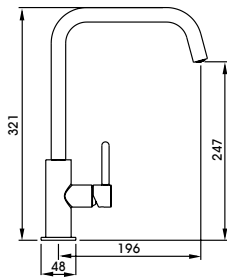

AT1259
Brushed Nickel



AT1269
Graphite



AT1270
Matt Black



AT1272
Urban Copper



AT2103
Brushed Brass



4 NEW COLOURWAYS
TO EXPLORE



AT2207
Matt White



AT2208
Scandi Grey



AT2209
Nude



AT2210
Terracotta

Full specification documents can be found at www.abodedesigns.co.uk

abode



AT1258
Chrome

Sleek contoured spout boasting a simple yet elegant design

Slim single lever handle makes it easy to use with the use of one finger to control water flow and temperature

Available in 10 finishes, find the perfect finishing touch for your design with the Althia every time

Image shows the Xcite 1.5 Bowl in Grey Metallic Granite and Althia Single Lever in Matt Black

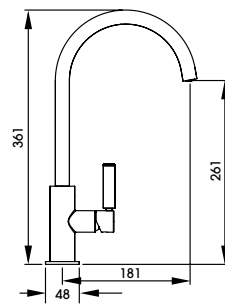

Globe
Single Lever

AT2146
Chrome



Perfectly in proportion. The slim body and sleek swan spout are the perfect combination

Discreet hot and cold indicators

Available in four finishes to perfectly compliment an array of kitchen designs



AT2147
Brushed Nickel



AT2149
Matt Black



AT2148
Brushed Brass

Full specification documents can be found at www.abodedesigns.co.uk

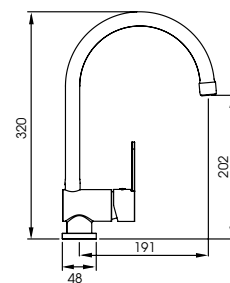

Czar
Single Lever

AT1241
Chrome



abode

The swan neck spout of the Czar gives it an elegant and contemporary design

Achieve precision water control at the touch of a single lever

An affordable and stylish option

Full specification documents can be found at www.abodedesigns.co.uk

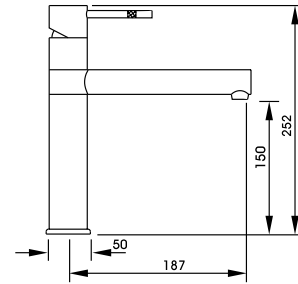

Hydrus Single Lever

AT1088
Chrome

AT1089
Brushed Nickel



Effortlessly control water flow and temperature with this sleek top lever tap

Featuring etched knurling detail on the handle, allowing for better grip but also adding attractive detail

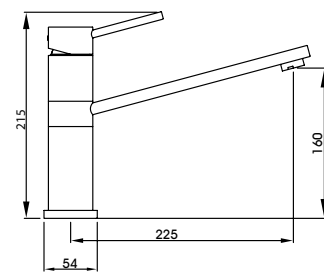

Specto Single Lever

AT1224
Chrome

AT1225
Brushed Nickel



Subtle sweeping design with soft lines and flat planes

Single handed control at the flick of a wrist

Standing at 160mm the Specto is great for compact kitchens with a smaller sink where space is at a premium



Image shows the Hydrus Single Lever in Chrome

MONOBLOCS

A monobloc allows for complete symmetry for some of the most elegant tap designs.

Function and design are perfectly balanced in this range. We are confident you'll find the perfect finishing touch to your kitchen with an Abode monobloc mixer.



Image shows the Atlas Monobloc in Brushed Brass



Image shows the Coniq R Monobloc in Polished Copper

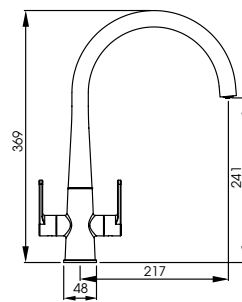

Coniq R

AT2123
Chrome



Stylish and contemporary conical style utilising advanced hydroforming manufacturing techniques

Smooth, rotating swan necked spout, with integrated aeration hidden from view with a cache aerator

Four hardwearing finishes available, including the durable and striking matt black and polished copper finishes



AT2124
Brushed Nickel



AT2125
Matt Black



AT2126
Polished Copper

Full specification documents can be found at www.abodedesigns.co.uk

Seeing is believing when it comes to the Atlas family. This best selling, sturdy monobloc has a brass construction so you can immediately appreciate the amount of material and craftsmanship that's gone into its design.

Atlas
Monobloc

AT1053
Chrome

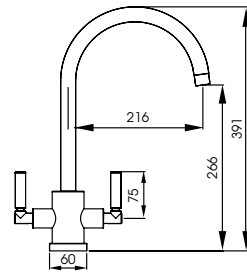

A combination of sophisticated modern styling and engineering excellence. The level of detail makes for a truly inspiring design to suit any kitchen style

Style, maximum performance and quality assurance embodied

This popular model is also available as an Aquifier Filter tap. See page 300 for details



AT1054
Brushed Nickel



AT2097
Matt Black



AT2096
Brushed Brass

Full specification documents can be found at www.abodedesigns.co.uk



Image shows the Belfast Ceramic Sink and Atlas Monobloc in Matt Black

Atlas
Quad

AT2166
Chrome



A quad spout addition to our best selling Atlas monobloc family

This sturdy monobloc has a solid brass construction, you can immediately appreciate the amount of material and craftsmanship that's gone into it's design

Style, performance and maximum quality assurance embodied

Opt for this quad spout version in one of four available finishes to add a serious style statement to your kitchen design



AT2167
Brushed Nickel



AT2169
Matt Black



AT2168
Brushed Brass

Full specification documents can be found at www.abodedesigns.co.uk



Image shows the GR15 1.0 bowl in Black Metallic Granite and Atlas Quad in Brushed Nickel

Atik
Monobloc

ATI 148
Chrome



abode
distinctly

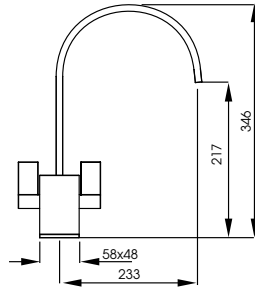

Bold and contemporary styling. Pair this bold tap with a traditional styled sink for a truly distinctive look

Achieve a unique look with the slimline squared swan spout

Three finishes available, including the durable and striking, powder coated matt black finish



Fluid
Monobloc

AT1169
Chrome



abode
distinctly

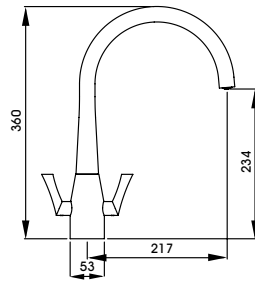

The name says it all. Fluidity of the design lines is the essence of this collection

Distinctive handle styling to add eye-catching detail to your kitchen design

Equally at home in classic or contemporary kitchen interiors alike



AT1170
Brushed Nickel

Full specification documents can be found at www.abodedesigns.co.uk

abode

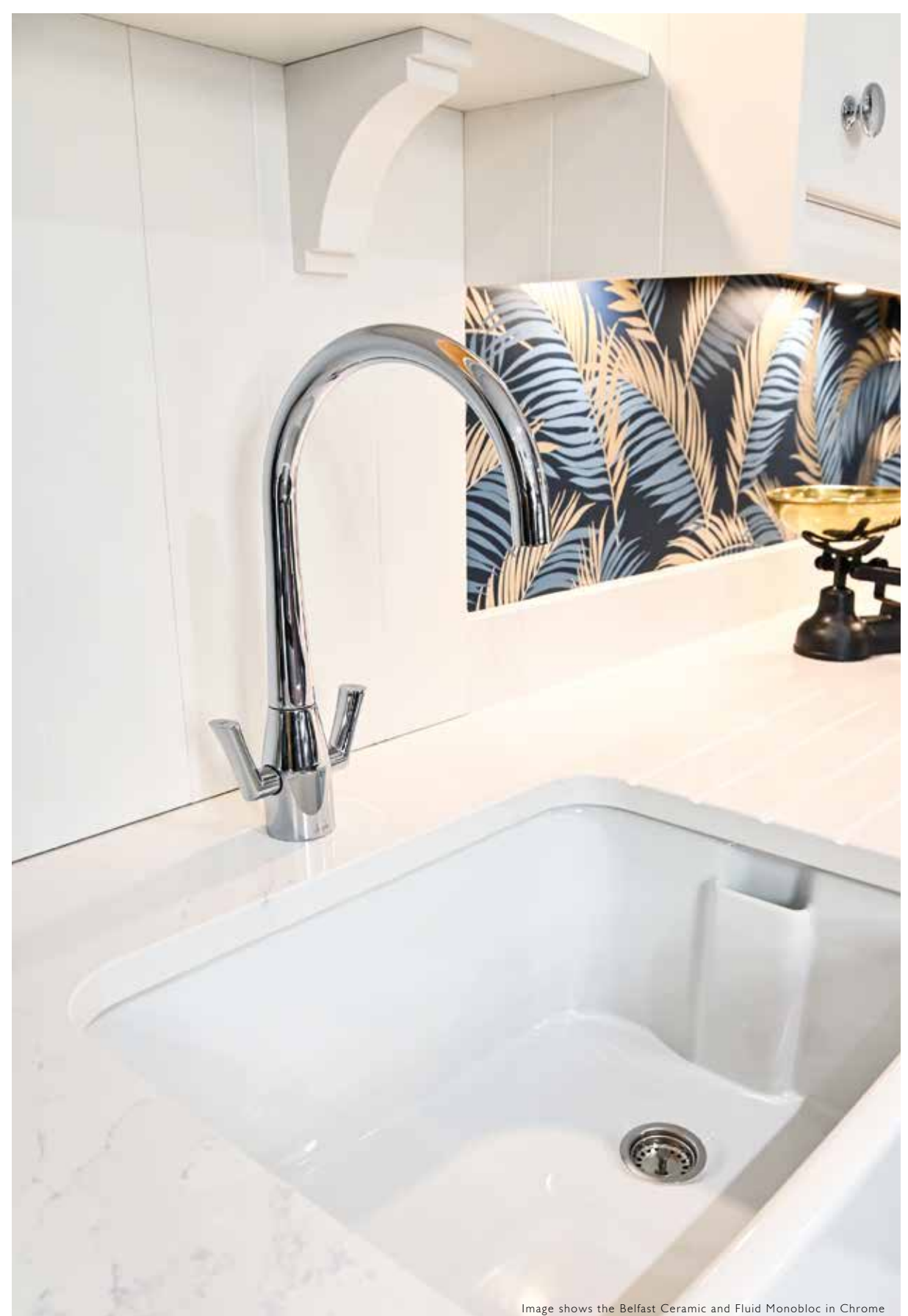
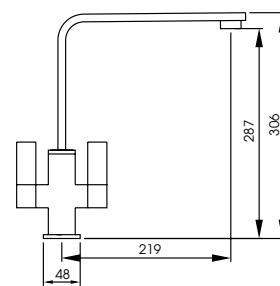

Image shows the Belfast Ceramic and Fluid Monobloc in Chrome



Image shows the Matrix R15 1.5 Bowl and Quantic Monobloc in Chrome



Quantic
Monobloc

AT2070
Chrome



Contemporary styling perfectly blending round and square forms

Classic monobloc design which is easy to operate with a simple movement

The tap spout will smoothly swivel between sink bowls



AT2105
Matt Black



AT2182
Brushed Brass

Full specification documents can be found at www.abodedesigns.co.uk



Image shows the Milford 1.5 Bowl and Globe Monobloc in Brushed Brass

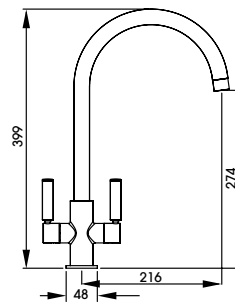

Globe Monobloc

AT2138
Chrome



Perfectly balanced. A classic looking monobloc design sure to provide the perfect finishing touch in a variety of kitchen designs

Contemporary handle styling with hot and cold indicators on the top of each handle

Choose from four of our most popular finishes



AT2139
Brushed Nickel



AT2141
Matt Black



AT2140
Brushed Brass

Full specification documents can be found at www.abodedesigns.co.uk

Globe Quad
Monobloc

AT2142
Chrome

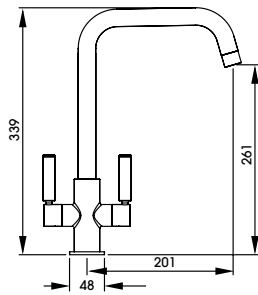

A contemporary twist. The addition of a quad spout gives this sleek design a modern edge

Contemporary handle styling with hot and cold indicators on the top of each handle

Four finishes to choose from



AT2143
Brushed Nickel



AT2145
Matt Black



AT2144
Brushed Brass

Full specification documents can be found at www.abodedesigns.co.uk



Image shows the Globe Quad Monobloc in Matt Black



Image shows the Zero 1.5 Bowl in Black Metallic Granite and Linear Nero Monobloc

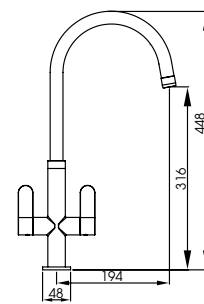

Linear Nero
Monobloc

AT1184
Chrome & Black



Bold and contemporary styling with a tall swan spout for great practicality

Durable and striking powder coated matt black detail contrasting luxurious chrome



Linear Flair Monobloc

AT1220
Chrome

AT1221
Brushed Nickel

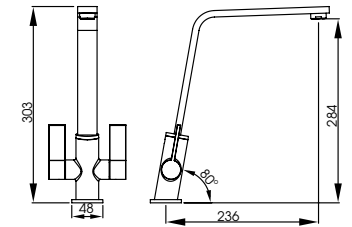

The 80-degree angle on the tap body results in a perfectly sloped design

Contemporary spout and handle styling makes for a striking addition to any modern kitchen



Nexa Monobloc

AT1222
Chrome

AT1223
Brushed Nickel

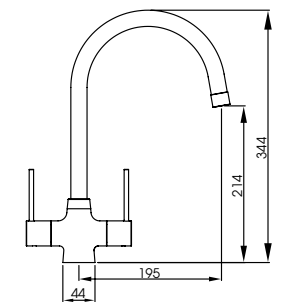

Slim, long-stem levers and a swan style spout make the Nexa elegant and easy to operate

Affordable, yet distinct design

Full specification documents can be found at www.abodedesigns.co.uk

Pico
Monobloc

AT1226
Chrome

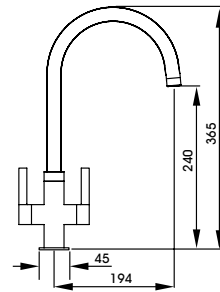

Elegantly styled monobloc with discreet hot and cold indicators on the handles

Four finishes available for design matching to key kitchen accessories/appliances

Pico features a simple yet stunning handle design to compliment the overall look



AT1227
Brushed Nickel



AT2095
Matt Black



AT2045
Brushed Brass

Full specification documents can be found at www.abodedesigns.co.uk



Image shows the Dune 1.5 Bowl in Frost White Granite and Pico Monobloc in Brushed Brass



Image shows the Milford 1.5 Bowl and Pico Quad in Brushed Brass

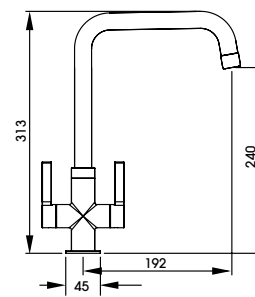

Pico
Quad

AT2134
Chrome



Quad spout version of the popular long standing Pico range
 Keeping the key design details of Pico, with the contemporary lift
 the quad spout options gives
 Four finishes available to perfectly complement key kitchen
 accessories/appliances



AT2135
Brushed Nickel



AT2137
Matt Black



AT2136
Brushed Brass

Full specification documents can be found at www.abodedesigns.co.uk



Astral Monobloc

ATI156
Chrome

ATI157
Brushed Nickel

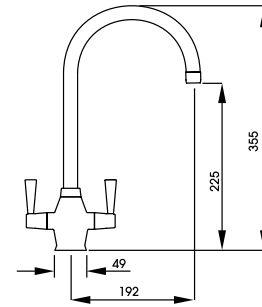

Classic styling suitable for contemporary and traditional settings alike

The distinctive body of the Astral is framed by the elegant swan spout and tapered handles



Althia Monobloc

ATI256
Chrome

ATI257
Brushed Nickel

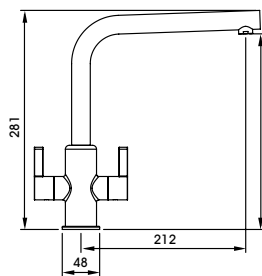

The blend of square and round forms gives the Althia its distinctive edge

Refined handle styling for optimum ease of use

Pair with a sink with distinctive drainer detailing for a striking effect



Image shows the Astral Monobloc in Brushed Nickel

PULL OUT & PROFESSIONAL TAPS

If you have the water pressure capability, a pull-out tap should not be overlooked. The cost may be slightly more up-front than a standard tap but the benefits over time will more than justify this.

The addition of a pull-out tap to the kitchen will make daily tasks such as pan filling, dish rinsing, food preparation and sink bowl cleaning that much simpler. Ideal for the keen cook or busy family household.

The range consists of two different types of pull out tap; a true pull out and a pull around tap. On a true pull out, the hose is discreetly hidden inside the tap and allows the user to pull the hose out to its full set length. A pull around tends to be a professional style tap in which the hose is visible on the external of the tap and held in a handspray holder located on the end of the extension bar.

In this range you'll find some products with an additional spray function which is operated by pressing a button on the end of the spout. This button simply changes the flow of the water from the standard to a powerful spray.

Our range of professional taps offer the manoeuvrability and features detailed above whilst being a statement piece in the kitchen.



Image shows the Genio Semi-Professional Monobloc pull around in Matt Black

See our stainless steel range for pull out and professional taps constructed from solid stainless steel.

Building on the success of the Tubist collection this uniquely styled tap adds an intuitive, ergonomic spray functionality in addition to the normal aerated water flow. Ideally suited to those looking for improved practicality without compromising on style, the Tubist T will be as easy in the hand as it is on the eye.

Tubist T
Pull Out Spray

AT2190
Chrome

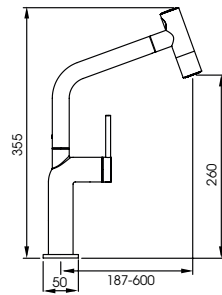

Ergonomic 'T' spray functionality for effortless flicking between standard and spray settings

Cool touch sprayhead for hot spraying practicality

Cold-start, ceramic disc technology: Mitigates unnecessary boiler operation and removes handle-to-wall interference

Bubble-Tec aerated water for improved water efficiency and reduced splashing

Supple-flex hose for enhanced pliability with 60cm reach, permitting access to the corners of the largest format sinks



Full specification documents can be found at www.abodedesigns.co.uk



Image shows the Tubist T in Matt Black



Image shows the Tubist Single Lever Pull Out in Matt Black

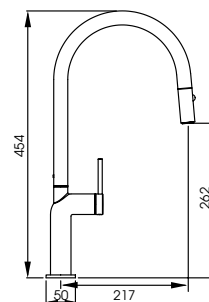

Tubist Single Lever
with pull out spray

AT2130
Brushed Nickel



Modern European styling lends everything to the curvaceous and organic form of Tubist

Using cold start valve technology, the environmentally friendly design will help save heat and wasted energy

Integrated pull down spray function, offering full or spray water functions

Three finishes available: Brushed Nickel, Matt Black & Polished Copper



AT2131
Matt Black



AT132
Polished Copper

Full specification documents can be found at www.abodedesigns.co.uk

Coniq R
Single Lever Pull Out

AT2119
Chrome

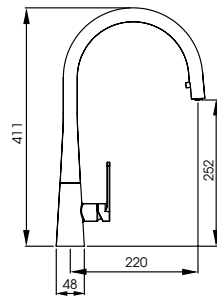

Stylish and contemporary conical style utilising advanced hydroforming manufacturing techniques

Smooth, rotating swan necked spout with integrated pull down weighted spray, with integrated aeration hidden that disappears when put back into place

Four hardwearing finishes available, including the durable and striking matt black and polished copper finishes



AT2120
Brushed Nickel



AT2121
Matt Black



AT2122
Polished Copper

Full specification documents can be found at www.abodedesigns.co.uk



Image shows the Matrix R0 Large Single Main Bowl and Coniq R Single Lever Pull Out in Brushed Nickel



Image shows the Hesta Monobloc Pull Out in Brushed Nickel

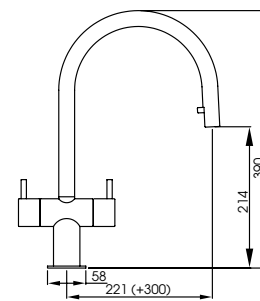

Hesta Monobloc Pull Out

AT1205
Chrome



Contemporary monobloc with hidden functionality, allowing easy cleaning of those hard to reach areas

Pull out formed from a grey Nylon hose. Set the pullout length you require using the counterbalance weight under the sink



Discreet pull out hose provides practicality without detracting from the minimal design



AT1206
Brushed Nickel

Full specification documents can be found at www.abodedesigns.co.uk

Virtue Nero Pull Out
with spray

AT1244
Chrome

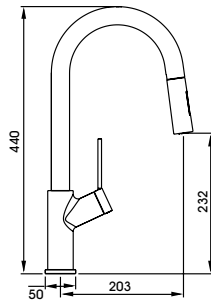

The contrasting black flexible spout makes it the perfect choice
for coordinating with other elements in the kitchen

With the added functionality of a pull-out hose with spray for
those harder to reach places

The unique 'V' shaped body and handle design of the Virtue
tap gives it a truly iconic look

Full specification documents can be found at www.abodedesigns.co.uk

abode



Image shows the Matrix GR15 2 Bowl In Black Metallic Granite and Virtue Nero Pull Out



Image shows the Tubist Professional in Matt Black

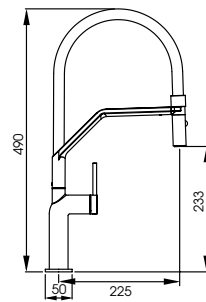

Tubist Professional
pull around with
detachable spray

AT2133
Matt Black



Taking its design cues from the Tubist range, the Professional tap offers greater versatility with a magnetic snap back control for the spout

Using cold start technology, this environmentally design will help save wasted heat and energy

Pull around hose feature, with spray and full flow water features

Durable silicone hose cover in black

Available in stylish and hardwearing matt black finish



Full specification documents can be found at www.abodedesigns.co.uk

In keeping with the solid geometric form of the Atlas collection, the professional range have the added functionality of a pull around spray.

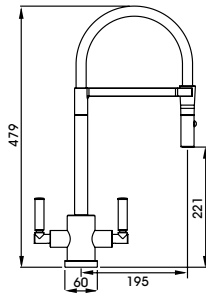

Atlas Professional Monobloc pull around with spray

AT1247
Chrome

AT1248
Brushed Nickel



Perfectly complement the décor of your kitchen with chrome or brushed nickel options with a black hose

Distinctive monobloc option

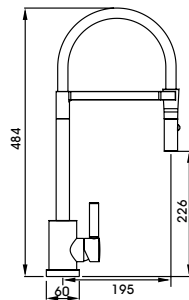

Atlas Professional Single Lever pull around with spray

AT1249
Chrome

AT1250
Brushed Nickel

AT2100
Matt Black



As well as the finish options above, you can also choose from a full matt black option with black hose

Simple to operate, energy efficient single lever option

Full specification documents can be found at www.abodedesigns.co.uk



Image shows the Stainless Steel Belfast and Atlas Professional Single Lever in Matt Black



Image shows the Genio Semi-Professional Monobloc in Chrome

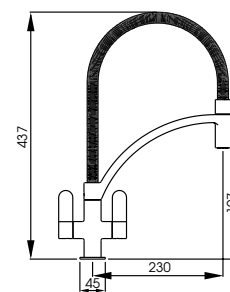

Genio Semi-Professional
Monobloc pull around

AT2071
Chrome



Semi-professional style mixer with detachable pull around spout feature, perfect for rinsing down and filling pans

Metal flexible hose for a truly professional look

Now available in a striking power coated matt black finish



AT2183
Matt Black

Full specification documents can be found at www.abodedesigns.co.uk

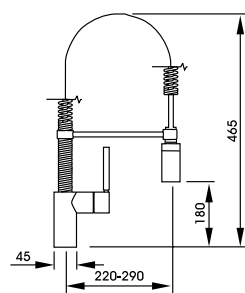

Ratio Professional
pull out

AT1115
Chrome



True functionality for ultimate flexibility, making cleaning and rinsing
chores simple

Maintain the look and feel of a professional tap whilst retaining a
relatively compact size

Full specification documents can be found at www.abodedesigns.co.uk



Image shows the Althia Pull Out in Chrome

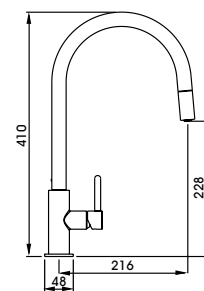

Althia
Single Lever Pull Out

AT1260
Chrome



The tall swan neck spout of the Althia pull out provides optimum flexibility, allowing you to reach into the corners of even the largest of sinks

Pull out formed from a grey Nylon hose. Set the pullout length you require using the counterbalance weight under the sink



The discreet pull out allows for a minimal design that maximises on both performance and style



AT1261
Brushed Nickel

Full specification documents can be found at www.abodedesigns.co.uk

Zest
Monobloc Pull Out

AT2164
Chrome

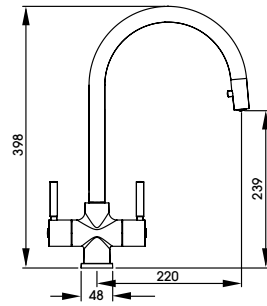

A balanced monobloc design with the added benefit of inbuilt functionality

Zest has a hidden pull out. The discreet hose is hidden away and located by a small toggle at the back of the spout maintaining the design lines of the product

The perfect helping hand for common rinsing tasks



The discreet pull out allows for a minimal design that maximises on both performance and style



AT2165
Brushed Nickel

Full specification documents can be found at www.abodedesigns.co.uk



Image shows the Neron 1.0 Bowl and Zest Monobloc Pull Out in Chrome.

Czar
Single Lever Pull Out

AT1240
Chrome

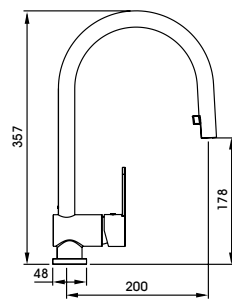

This simple single lever design features a discreet grey Nylon pull out hose. The pull out length can be set as required using the counterbalance weight under the sink

Smooth and effortless single lever control

Supplied complete with flexible tail pipes for fast and simple fitting



Discreet pull out hose provides practicality without detracting from the minimal design

Full specification documents can be found at www.abodedesigns.co.uk



Image shows the Czar Single Lever Pull Out in Chrome



Image shows the Ophelia Professional pull around with spray in Chrome



Globe Professional

AT2150
Chrome

AT2151
Brushed Nickel

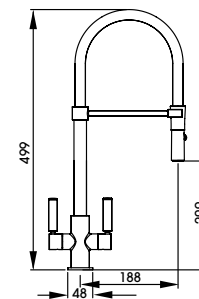

The same slim and sleek Globe body with added functionality

Pull around hose with spray feature integrated

Contrasting, durable silicone hose cover



Ophelia Professional pull around with spray

AT2074
Chrome

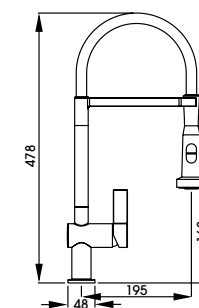

Features pull around, switchable spray function, perfect for rinsing and cleaning tasks

Professional style, an ideal kitchen addition for the keen cook or baker

Ceramic disc valve technology for ultra smooth water flow and temperature control

Full specification documents can be found at www.abodedesigns.co.uk

STAINLESS STEEL TAPS

Stainless steel as a material has several well loved benefits including:

It is a closer match to stainless steel sinks and appliances

The material itself is 100% recyclable

Stainless steel taps have no coating, they are just polished and brushed

It is more durable and less likely to scratch, small scratches can be brushed out

Stainless steel is a naturally hygienic material



Image shows the Stalto Professional



Image shows the Matrix R15 1.5 Bowl Sink and Axial Pot Filler

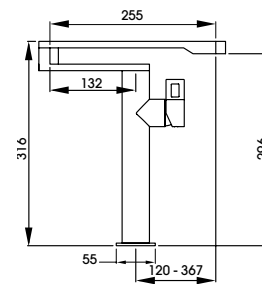

Axial
Pot Filler

AT2078
Stainless Steel



- Pot filler style functionality in a simple to fit deck mounted format
- Easily reach each corner of the sink or fill large pans from the worktop rather than in the bowl due to multiple swiveling spout joints
- Solid 304 stainless steel construction
- Unique, innovative and practical design
- Delivers hot, cold & mixed temperature water

The Axial can be deck or sink mounted



Full specification documents
can be found at
www.abodedesigns.co.uk

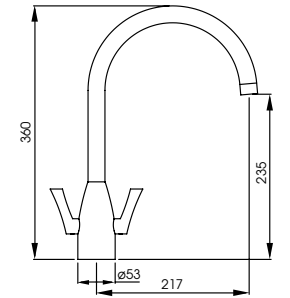

Image shows the Propus Single Lever



Airo Monobloc

AT2075
Stainless Steel



Beautiful organic curves created from solid stainless steel this elegant and durable, monobloc can sit in modern and traditional kitchens alike

Quarter turn handle action for precise flow control

Anti-splash spout design



Propus Single Lever

AT1070
Stainless Steel

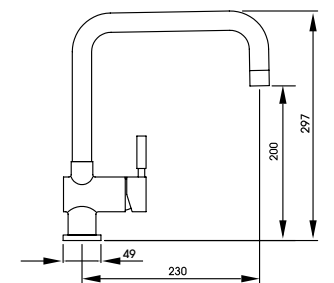

Architectural inspired design

Smooth single lever control

A clean lined, contemporary styled mixer tap. The perfect pairing for any stainless steel or granite sink

Full specification documents can be found at www.abodedesigns.co.uk

Stalto Professional
pull out with spray

ATI 199
Stainless Steel

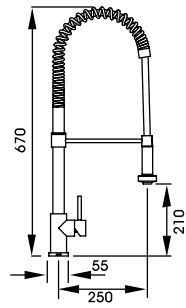

Standing tall at 670mm, the Stalto is a truly showstopping piece in any kitchen

Coiled construction with a balanced spray head and integrated spray button

The ultimate choice for the keen cook or aspiring chef

Full specification documents can be found at www.abodedesigns.co.uk

abode



TAPS

STAINLESS STEEL 257

Image shows the Stalto Professional



Taura Monobloc

AT1137
Stainless Steel

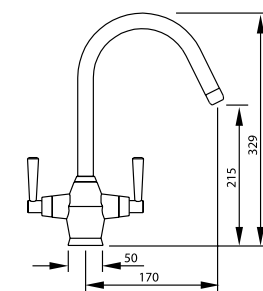

An elegant design featuring soft, smooth curves

A traditional style which boasts the hygienic and practical properties of stainless steel

Discreet hot and cold indicators on the handle ends



Quala Single Lever

AT1198
Stainless Steel

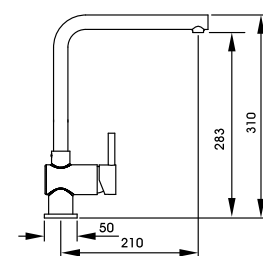

Distinctive L shaped spout design for a contemporary, minimalist look

Smooth single lever control

Would sit perfectly with any style of sink

Full specification documents can be found at www.abodedesigns.co.uk



Focal Monobloc

AT2177
Stainless Steel

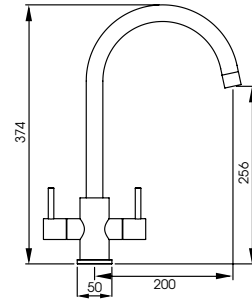

Balanced, contemporary monobloc styling with the well-loved benefits of stainless steel

Ceramic disk valve technology for super smooth flow and temperature control

Fitted with an anti-splash aerator for a premium finish



Sway Single Lever

AT2178
Stainless Steel

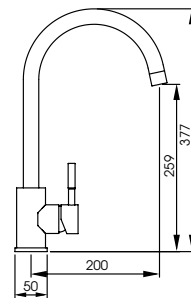

Contemporary side single lever styling featuring soft, smooth curves

A sleek swan neck design which boasts all the benefits of stainless steel alongside

Ceramic cartridge technology for smooth flow and temperature control



Image shows the Sway Single Lever in Stainless Steel

TRADITIONAL TAPS

Inspired by the classic era of British design and manufacturing, this refined selection of distinctive traditional mixertaps will bring truly classic style to your kitchen.



Image shows the Ludlow Monobloc in Antique Brass

TAPS

TRADITIONAL 263

Gosford
Monobloc

AT1019
Chrome

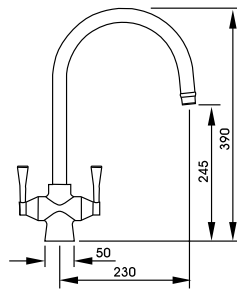

A tall sweeping swan neck spout and smooth tapered handles fuse with the symmetrical body to create a tap of modern-day elegance

Traditional style hot and cold indicators on the top of the handles

This model is also available as an Aquifer Filter tap. See page 306 for details



AT1020
Brushed Nickel



AT1022
Antique Brass

Full specification documents can be found at www.abodedesigns.co.uk



Image shows the Gosford Monobloc in Antique Brass

Ludlow
Monobloc

AT1026
Chrome

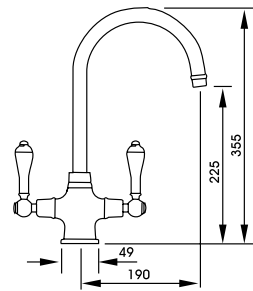

Timeless classic Victorian inspired design

Ceramic style handles with traditional hot and cold indicators
on the end of each handle

A balanced combination of age-old design inspiration with
modern engineering technology



AT1028
Antique Brass



AT1216
Brushed Nickel

Full specification documents can be
found at www.abodedesigns.co.uk



Image shows the Ludlow Monobloc in Brushed Nickel

Ludlow
Bridge

AT1029
Chrome



abode

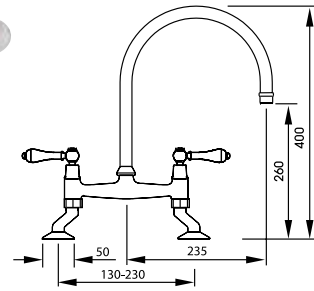

Timeless classic Victorian inspired design

Ceramic style handles with traditional hot and cold indicators
on the end/top of each handle

A balanced combination of age-old values with modern
engineering technology



AT1031
Antique Brass



AT1217
Brushed Nickel

Full specification documents can be
found at www.abodesigns.co.uk

abode



Image shows the Ludlow Bridge in Brushed Nickel



Image shows the Milford 1.5 Bowl Ceramic and Burford Monobloc in Antique Brass

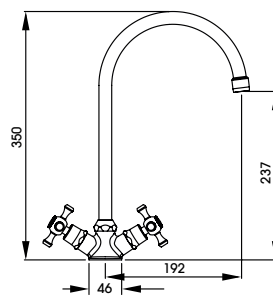

Burford Monobloc

AT2170
Chrome



Inject simple, yet sophisticated traditional design into the kitchen with the Burford

The handles feature quarter turn ceramic disk valves for ease of use

Traditional hot and cold indicators feature on the cross handles

Available in three finishes including the popular Antique Brass



AT2171
Brushed Nickel



AT2172
Antique Brass



A classic continental design

Originating from France, the Melford's farmhouse styling proves a successful fusion of provincial design and modern engineering technology

Finished off with traditional hot and cold indicators on the handles and knurling detail on the spout

Revolve aerator supplied as standard



Image shows the Melford Monobloc in Chrome



Melford Monobloc

AT1041
Chrome



AT1043
Antique Brass



AT1044
Brushed Nickel

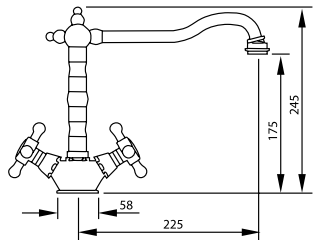

Melford Bridge

AT1045
Chrome



AT1047
Antique Brass



AT1048
Brushed Nickel

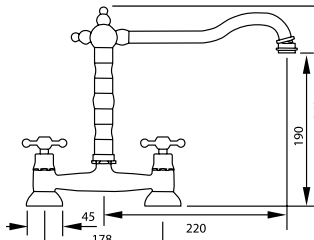

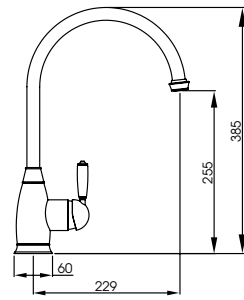

Astbury Single Lever

AT3004
Chrome

AT3006
Pewter

AT3070
Forged Brass



The perfect addition to an understated, traditional kitchen design. Single lever design for smooth single handed control makes this Astbury product as functional as it is sleek.

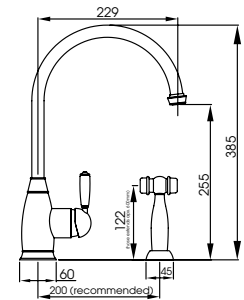

Astbury Single Lever with Integrated Handspray

AT3005
Chrome

AT3007
Pewter

AT3071
Forged Brass



For complete functionality select models with the integrated handspray, delivering any mix of hot and cold water through the handspray.



Image shows the Belfast and Astbury Single Lever in Chrome

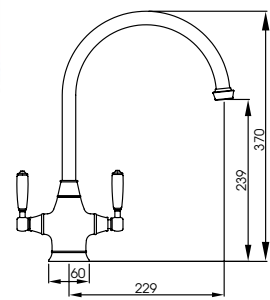

Astbury Monobloc

AT3000
Chrome

AT3002
Pewter

AT3068
Forged Brass

Sleek, traditional styling embodied. Featuring real ceramic handles with smooth, quarter turn function.

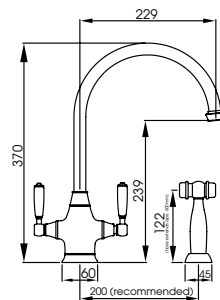

Astbury Monobloc with Integrated Handspray

AT3001
Chrome

AT3003
Pewter

AT3069
Forged Brass

For complete functionality select models with the integrated handspray, delivering any mix of hot and cold water through the handspray.



Full specification documents can be found at www.abodedesigns.co.uk



Image shows the Astbury Monobloc in Forged Brass

The perfect addition to those seeking authentic traditional style

Quarter turn handle action for precise flow control

Real ceramic handles and adjustable centre inlets to fit any sink

Handspray models come with independent handspray for cold water spray only



Astbury Bridge

AT3008
Chrome

AT3010
Pewter

AT3072
Forged Brass

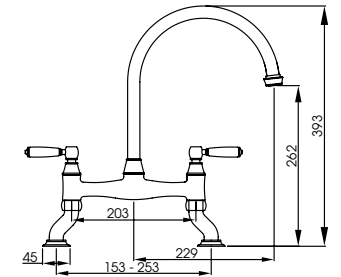

Astbury Bridge with Integrated Handspray

AT3009
Chrome

AT3011
Pewter

AT3074
Forged Brass

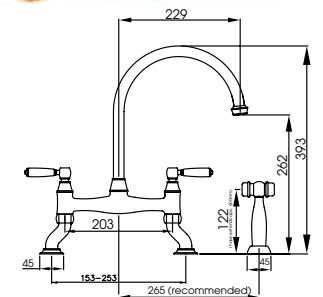

Full specification documents can be found at www.abodedesigns.co.uk

The curvaceous Astbury Mixer oozes class with its fluid lines

Victorian inspired styling and real ceramic handles

Handspray models come with independent handspray for cold water spray only



Image shows the Astbury 3 Part Mixer in Chrome



Astbury 3 Part Mixer

AT3046
Chrome

AT3047
Pewter

AT3073
Forged Brass

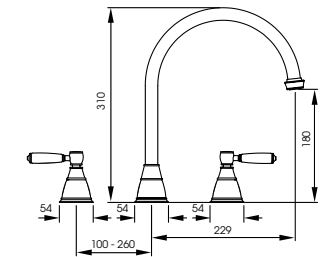

Astbury 3 Part Mixer with Integrated Handspray

AT3050
Chrome

AT3051
Pewter

AT3075
Forged Brass

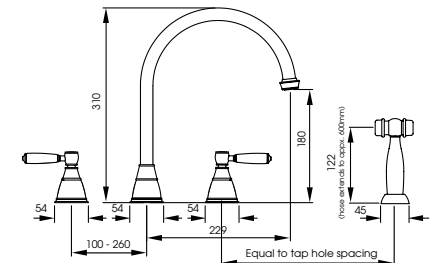

Full specification documents can be found at www.abodedesigns.co.uk

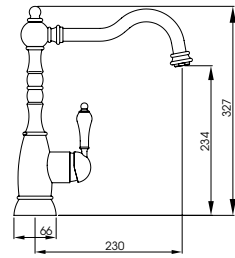

Bayenne Single Lever

AT3028
Chrome

AT3030
Pewter

AT3087
Century Copper



It's the fine, sophisticated detailing and classic French design which epitomise the Bayenne family of products. This traditional design has a contemporary edge in the form of the single lever handle for effortless single handed control.

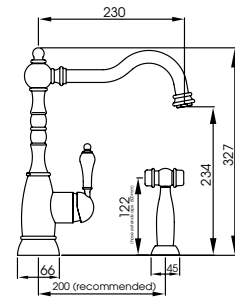

Bayenne Single Lever with Integrated Handspray

AT3029
Chrome

AT3031
Pewter

AT3088
Century Copper



For complete functionality select models with the integrated handspray, delivering any mix of hot and cold water through the handspray.





Bayenne Monobloc

AT3024
Chrome

AT3026
Pewter

AT3090
Century Copper

The fine and sophisticated detailing on this traditional monobloc includes hot and cold indices on the quarter turn handles offering precise flow control

Classic French design, available in three finishes



Bayenne Monobloc with Integrated Handspray

AT3025
Chrome

AT3027
Pewter

AT3086
Century Copper

For complete functionality select models with the integrated handspray, delivering any mix of hot and cold water through the handspray.



Full specification documents can be found at www.abodedesigns.co.uk



Image shows the Bayenne Monobloc in Pewter

The ultimate statement piece for a rustic, traditional kitchen design

Classic in style and bursting with personality, the detailing on the Bayenne Bridge will undoubtedly make it a stand out piece and focal point in your kitchen

Handspray models come with independent handspray for cold water spray only



Image shows the Bayenne Bridge in Pewter



Bayenne Bridge

AT3032
Chrome

AT3034
Pewter

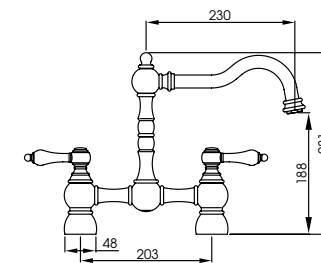

Bayenne Bridge with Integrated Handspray

AT3033
Chrome

AT3035
Pewter

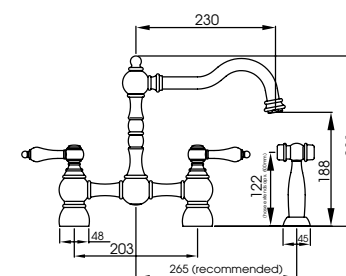



Image shows the Brompton Single Lever with Integrated Spray in Chrome



Brompton Single Lever

A3016
Chrome

AT3018
Pewter

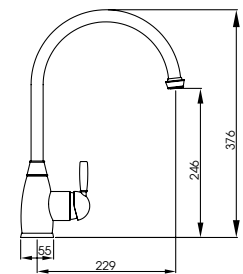

The smooth action of the single lever handle makes for effortless control and precision flow

Premium simplicity embodied



Brompton Single Lever with Integrated Handspray

AT3017
Chrome

AT3019
Pewter

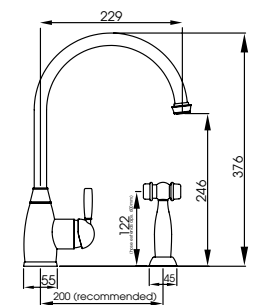

For complete functionality select models with the integrated handspray, delivering any mix of hot and cold water through the handspray.

Full specification documents can be found at www.abodedesigns.co.uk



Image shows the Brompton Monobloc in Pewter



Brompton Monobloc

A3012
Chrome

AT3014
Pewter

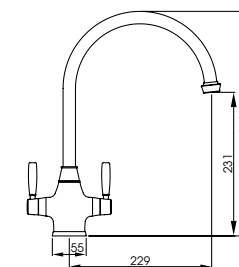

It's the finer details that make all the difference and the Brompton Monobloc demonstrates this perfectly

With its smooth lines, curvaceous body and sleek handle detailing, this design classic will sit perfectly in a variety of kitchen styles



Brompton Monobloc with Integrated Handspray

AT3013
Chrome

AT3015
Pewter

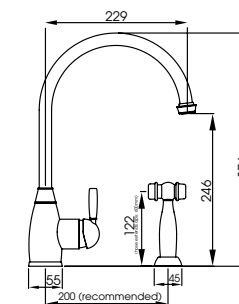

For complete functionality select models with the integrated handspray, delivering any mix of hot and cold water through the handspray.

Full specification documents can be found at www.abodedesigns.co.uk



Brompton Bridge

AT3020
Chrome

AT3022
Pewter

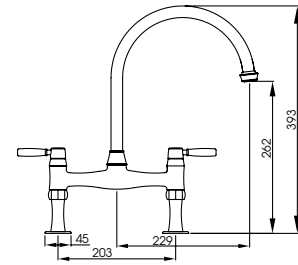

A modern reflection of the classic themes of vintage British design

Imposing style will grace all kitchens

Modern quarter turn handles are housed on sleek styled, fluted legs adding welcome detailing to this elegant mixertap



Brompton Bridge with Integrated Handspray

AT3021
Chrome

AT3023
Pewter

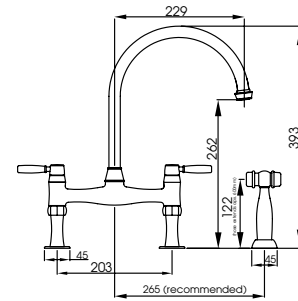

Handspray models come with independent handspray for cold water spray only.



Image shows the Brompton Bridge in Chrome.



Brompton 3 Part Mixer

AT3044
Chrome

AT3045
Pewter

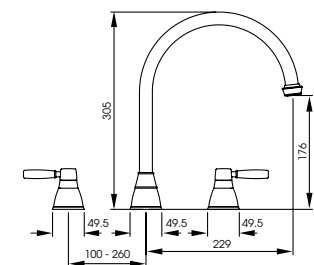

The sleek, fluid lines of the Brompton 3 Part Mixer make it the perfect pairing for our range of undermount ceramic sinks or stainless steel undermount sinks

The understated design gives a truly elegant, premium finish



Brompton 3 Part Mixer with Integrated Handspray

AT3048
Chrome

AT3049
Pewter

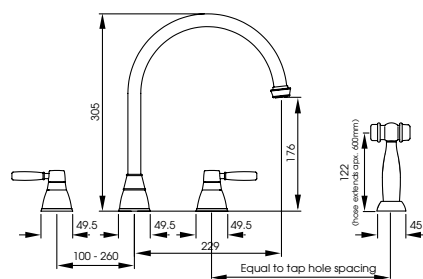

Handspray models come with independent handspray for cold water spray only.



Image shows the Brompton 3 Part Mixer in Chrome

Hendon Handspray

AT3040
Chrome



abode
distinctly

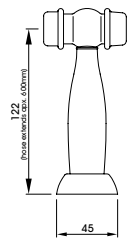

For an independent spray function add the Hendon handspray to any of the single lever, monobloc or 3 part mixers

Delivers a cold water supply through the handspray, making those daily tasks that little bit simple



AT3041
Pewter



AT3101
Forged Brass



AT3103
Century Copper

Full specification documents can be found at www.abodedesigns.co.uk



Image shows the Hendon Handspray in Forged Brass

AQUIFIER™ WATER FILTER TAPS

The Abode Aquifier range features popular designs from our tap range as well as exclusive designs with the added benefit of a dedicated filtered water function – straight from the tap.



Image shows the Belfast and Atlas Aquifier in Matt Black

WHAT ARE THE BENEFITS OF A WATER FILTER TAP?



WATER QUALITY: An Aquifier tap or Swich device filters particulates from water, reduces the taste and odour of chlorine and reduces hardness from the water.



HEALTH: Having filtered cold water on tap will hopefully encourage the consumption of more water. Fill a reusable water bottle each day directly from the tap.



ENVIRONMENT: By removing the need for bottled mineral water, every home with an Aquifier product is doing their bit for the environment by reducing single use plastic consumption.



COST: If bottled mineral water is a frequent purchase in your household you can save considerable amounts each year by switching to an Aquifier or Swich product.

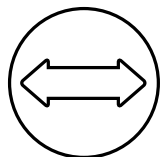

SPACE SAVING: If you previously had a water filtration jug or bought bottled water, just think how much space you can free up in the fridge.



APPLIANCE HEALTH: If you live in an area with particularly hard water you will notice that the kettle suffers as a result of the limescale build up over time. Fill your kettle with filtered water and prolong its life.

Find out more on the website: <https://www.abodedesigns.co.uk/faqs/aquifier>

HOW DOES AN AQUIFIER PRODUCT WORK?



WHY IS IT IMPORTANT TO KEEP UP WITH REPLACEMENT FILTERS?

It is simple to maintain your filter, it sits in a bracket either at the back or on the side of the inside of the base cabinet below the sink. It is easy for anyone to replace using our simple, fast and secure 'SafeLock' system.

We offer a dedicated filter reminder service – we'll send you a reminder by email or post each time your filter is due for renewal.

Filters are easy to buy as singles or packs from www.abode-shop.co.uk when the time comes to replace.

It's important to change the filter at the recommended intervals to ensure the consistency of the supply of fresh, filtered drinking water.

USAGE: The capacity of the filter units for Aquifier and Swich products vary, these range between 1000L and 6000L (dependent on incoming water quality and usage).

We have both Classic and High Resin filters available, specifically tailored for use in soft water or hard water areas respectively.

If you live in a soft water area the filter will be used up much slower than one in a hard water area (based on a standard average usage).

We recommend that our filters are changed every 6 months on average. If you live in a hard water area or have a higher filtered water consumption, replacements every 3 months may be beneficial.



RECYCLE SCHEME AVAILABLE

The Safelock high resin filter is included as part of the FREE Abode filter recycle scheme.



REDUCE
WATER
WASTAGE

NEW

Naturalé
Aquifier

AT2195-F5
Chrome



abode
distinctly

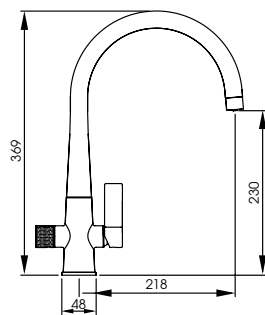

A tap with a conscience, one that is maximal on style and minimal on impact. The Naturalé has been designed and developed by Abode to be our most sustainable tap.

Designed with a FSC approved Beech wood approved handle which, with a simple twist gives you access to crystal clear filtered water, helping you become part of the solution to plastic pollution.

Supplied with a filter that is part of our filter recycle scheme. Doing our bit, to help you do your bit.

The unique, teardrop lever controls your domestic water with a cold start valve, helping to reduce energy wastage.



Full filter starter kit
supplied



AT2196-F5
Brushed Nickel



AT2197-F5
Matt Black



TAPS

WATER FILTERS 303

Image shows the Naturalé Aquifier in Brushed Nickel.

Full specification documents can be found at www.abodedesigns.co.uk
For replacement filters, please visit www.abode-shop.co.uk

Atlas
Aquifier

AT2003
Chrome

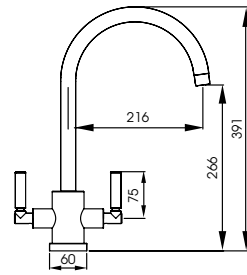

Maintain the sleek and popular style of the Atlas tap with the addition of filtered cold water

Cold, hot and pure indicators on the top of the handles

Four finishes available, achieve the perfect finishing touch with the benefit of added functionality

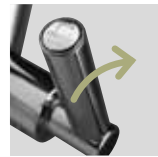

Push the cold lever back for filtered water



Full filter starter kit supplied



AT2004
Brushed Nickel



AT2099
Matt Black



AT2098
Brushed Brass



TAPS

WATER FILTER 305

Image shows the Atlas Aquifier in Matt Black

Full specification documents can be found at www.abodedesigns.co.uk
For replacement filters, please visit www.abode-shop.co.uk

Gosford
Aquifier

AT2005
Chrome

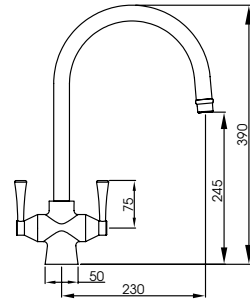

The classic Gosford design attributes are maintained but combined with the added benefit of Abode's unique integrated water filtration technology

The flow of hot, cold and filtered water goes through the same spout and using just two handles

Traditionally styled hot, cold and pure indicators on top of the handles



Push the cold lever back for filtered water



Full filter starter kit supplied



AT2006
Brushed Nickel

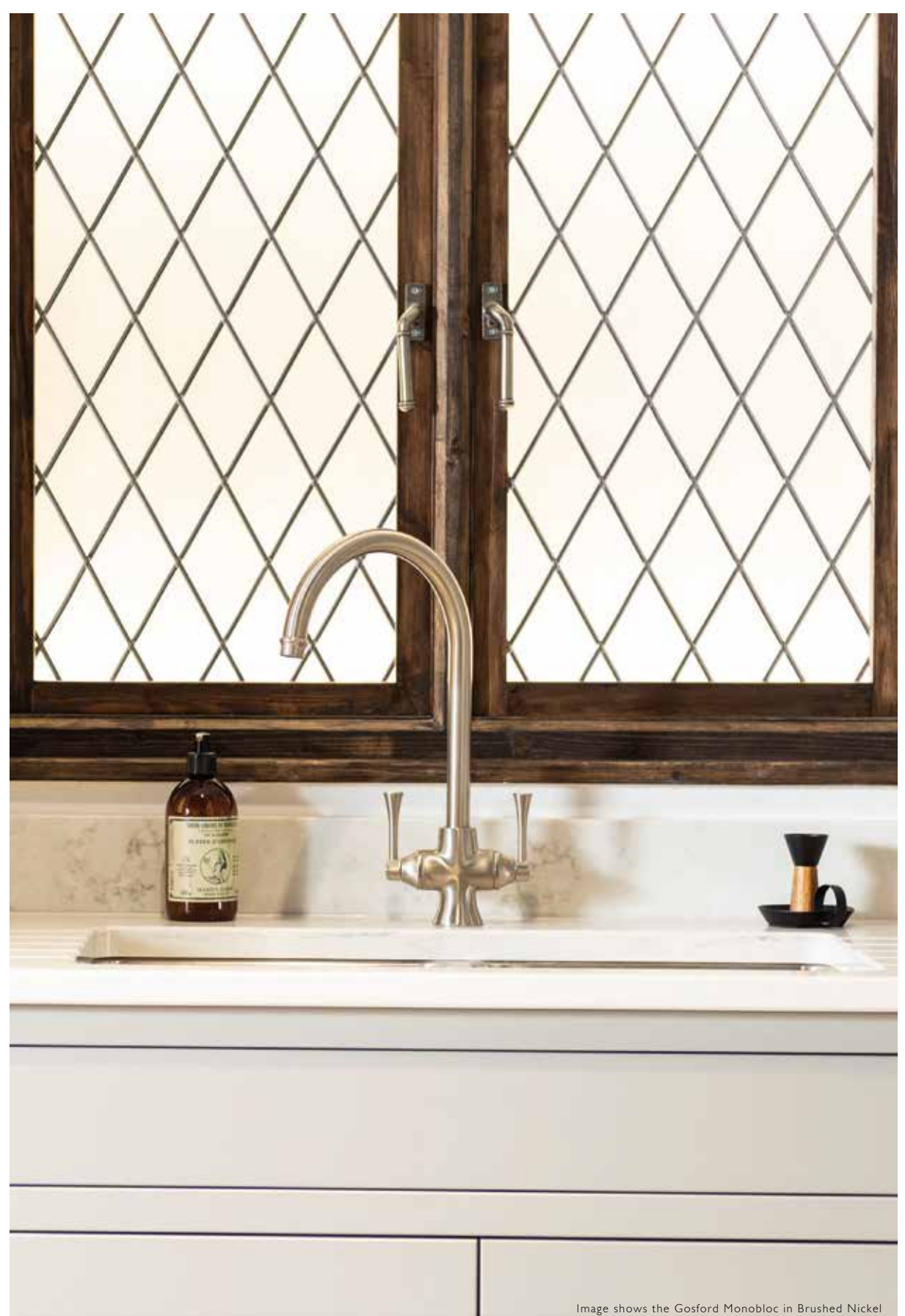

TAPS

WATER FILTER 307

Image shows the Gosford Monobloc in Brushed Nickel

Full specification documents can be found at www.abodedesigns.co.uk
For replacement filters, please visit www.abode-shop.co.uk



Image shows the Sandon 1.5 Bowl and Orcus 3 Way Aquifier in Chrome

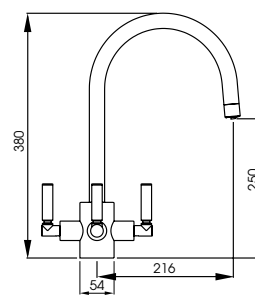

Orcus 3 Way Aquifier

AT2072
Chrome



- Dedicated hot, cold and filter control handles (filter control at the front of the tap)
- Dedicated filtered water pathway (doesn't share with hot & cold)
- Anti-splash spout design

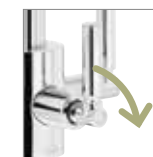

Turn the middle lever clockwise for filtered water



Full filter starter kit supplied

Puria
Aquifier

AT2042
Chrome

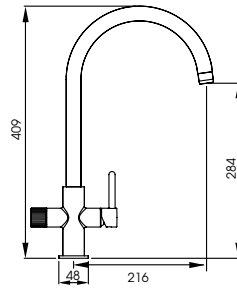

Abode lead the market in innovative filter water taps and the latest addition to the range is no exception

It has a single lever cold start valve offering smooth flow and temperature control. Filtered drinking water is delivered through a separate channel delivering refreshingly fresh filtered water.

Modern engineering makes this probably the slimmest filter tap available today

Tall swan spout, with in built aeration keep filtered water and potable supplies separate



Rotate the filter lever back for filtered water



Full filter starter kit supplied



AT2043
Brushed Nickel



AT2044
Matt Black



TAPS

WATER FILTER 311

Image shows the Puria Aquifier in Matt Black

Full specification documents can be found at www.abodedesigns.co.uk
For replacement filters, please visit www.abode-shop.co.uk

Globe
Aquifier

AT2173
Chrome

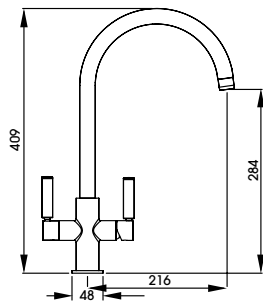

Enjoy the design of the Globe monobloc with the addition of filtered cold water when you opt for this Aquifier tap

Filtered water indicator on the top of the left handle and tap body

Four finishes available, achieve the perfect finishing touch with the benefit of functionality built in



Full filter starter kit
supplied



AT2174
Brushed Nickel



AT2176
Matt Black



AT2175
Brushed Brass



Image shows the Dune in Frost White Granite and Globe Aquifier in Chrome



Introducing (sw)ich

A revolution in filtered water technology

HOW DOES A SWICH PRODUCT WORK?

Convert **ANY** kitchen tap to one which delivers filtered water as well as the standard cold water supply

The easy way to get filtered water from any style of tap

Simple to install either through the worktop, or any standard sink 35mm tap hole or even in the sink cabinet

Easy to use, just turn to divert to the filtered water function and back again to the standard cold water supply

Can be installed alongside a new tap or retro-fit with an existing tap

Award winning, unique product design

MAKE THE SWITCH FROM BOTTLED WATER, SAVE MONEY AND THE ENVIRONMENT

See our cost saving infographic, video and supporting information at www.abodedesigns.co.uk

Scan to visit our YouTube channel for a selection of Swich videos.



RECYCLE SCHEME

FILTERED WATER

SPACE SAVING

REDUCE PLASTIC



FILTERED
WATER
FROM ANY TAP



Swich
Round

0.5 hot 1.0 cold abode

[with classic filter]

AT2050

Chrome

AT2051

Brushed Nickel

AT2106

Matt Black

AT2109

Brushed Brass

AT2201

Beech Wood

[with high resin filter
for harder water]

AT2054

Chrome

AT2055

Brushed Nickel

AT2107

Matt Black

AT2110

Brushed Brass

AT2202

Beech Wood

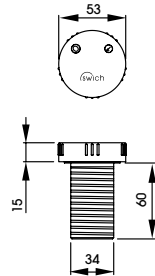

Full filter
starter kit
supplied
with each
swich



Full specification documents can be found at www.abodedesigns.co.uk
For replacement filters, please visit www.abode-shop.co.uk



Improve the overall taste and quality of the drinking water from any tap by adding a Swich device

Swich is easy to install and use, simply twist the device to divert the cold water to refreshing, filtered water and back to unfiltered cold water as desired

Choose from an array of finishes to perfectly complement your tap and kitchen design

To ensure the perfect solution, choose from two filter options. Choose the Classic Filter for soft water areas and the High Resin filter for hard water areas to ensure maximum longevity of the filter

HANDSPRAYS AND ACCESSORIES



AT1100
Chrome

AT1101
Brushed Nickel



Axell
Handspray
Rinse

AT1107
Stainless Steel



Hendon
Handspray

AT3040
Chrome

AT3041
Pewter



AT3101
Forged Brass

AT3103
Century Copper

Note: All handsprays should be used in conjunction with a pressure reduction valve (not supplied)

WATER FILTER CARTRIDGES

Aquifier
Filter Cartridge

AT2002



Aquifier High
Resin Filter
Cartridge

AT2040



PROBOIL.2X
Filter Cartridge

PT1206



PROBOIL3
Filter Cartridge

PT1024



Swich Classic
Filter Cartridge

AT2111



Swich High
Resin Filter
Cartridge

AT2112



Note: Replacement Aquifer/Swich filter cartridges can be bought from www.abode-shop.co.uk
Replacement Pronteau filter cartridges can be bought from www.pronteau.co.uk

VALVES AND BRACKETS

Flow Control
Valve

AT1142
Brass



15mm Flow
Restriction Valve
4 litres/minute

AB2434

to suit 15mm
pipe fittings

3 litres/minute

AB2440

to suit 15mm pipe fittings



15mm Flow
Restriction Valve
6 litres/minute

AT2435

to suit 15mm
pipe fittings



1/2" Showerhead Flow
Restriction Valve
6 litres/minute

AT2433

replaces any 1/2"
shower hose seal



Tap Support
Bracket

AX1011
Stainless Steel

AERATORS

Revolve
Aerator

A swiveling joint
that attaches to your
existing spout

AT1060

Revolve Aerator



Jetspray
Aerator

AT1140
Chrome Jet Spray



 indicates taps suitable for this extra feature

 indicates taps suitable for this extra feature

SYSTEM SYNC ACCESSORIES



System Sync
Prep Board

AX2024



System Sync
Colander

AX1508



System Sync
Flex Rack

AX2506



INDEX

SINKS

Acton	74
Aspekt	56
Belfast	46
Connekt	80
Denton	42
Dune	58
Ixis	82
Matrix GR15	38
Matrix R0	20
Matrix R15	24
Matrix R50	28
Mikro	84
Milford	76
Neron	86
Oriel	62
Provincial	48
Sandon	50
Stainless Steel Belfast	32
Studio Compact	34
System Sync	16
Trydent	90
Verve	92
Xcite	64
Zero	68

TAPS

Accessories	318
Aerators	319
Agilis	172
Airo	255
Althia	186, 220, 242
Astbury	274, 276, 278, 280
Astral	220
Atik	202
Atlas	180, 198, 200, 236, 304
Axial	252
Bayenne	282, 284, 286
Brompton	288, 290, 292, 294
Burford	270
Coniq R	174, 196, 228
Coniq S	176
Czar	190, 246
Fluid	204
Focal	260
Fraction	162, 144, 166
Genio	238
Globe	188, 208, 210, 249, 312
Gosford	264, 306
Handsprays	296
Hesta	230
Hex	152, 154, 156, 158, 160
Hydrus	192
Industria	112
Linear Flair	214
Linear Nero	212
Ludlow	266, 268
Melford	272
Naturalé	302
New Media	182
Nexa	215
Orcus	308
Ophelia	248
Pico	216, 218
Prime	184
ProBoil.2X	146
ProBoil.4E	146
Professional 3 IN 1	124
Profile	136, 138
Project	140, 142
Propure	130, 132
Propus	254
Prostream	120
Prostyle	122
Prothia	114, 116
Protrad	188, 128
Province	144
Puria	310
Quala	259
Quantic	206
Ratio	240
Specto	192
Stalto	256
Sway	260
Swich	314, 316
Taura	258
Tubist	178, 224, 226, 234
Virtue Nero	232
Warranty & Care	322
Water Filter Cartridges	318
Zest	244

WARRANTY

COMPREHENSIVE WARRANTY

In the unlikely event that you should experience any defect in the materials or workmanship of your new

- Abode sink within 10 years of purchase
- Abode tap within 5 years of purchase
- ProBoil boiler within 2 years of purchase

The purchaser's sole remedy shall be the replacement (at the manufacturer's discretion) of all or any part of the product that is defective.

For the tap, all working parts and valves are guaranteed for a period of 5 years from date of purchase. Decorative surface finishes and O-rings are guaranteed for 1 year from the date of purchase provided that our advice concerning care has been observed and no scouring agents have been used.

This is provided that the sink, mixer or tap has been used for normal domestic purposes and that the care, installation and maintenance instructions have been observed. The warranty extends to the original purchaser only.

CUSTOMER CARE

CAUTION

Repeated release of boiling hot water directly into coloured sinks can in extreme cases cause crazing and even cracking. Therefore we recommend great care is taken not to release the water directly on to the sink surface at full temperature for extended periods.

WATER REGULATIONS

All products should be installed in accordance with Local Water Bye Laws.

Visit www.abodedesigns.co.uk to search all products with a current WRAS approval.

Our ProBoil boilers store water at a maximum temperature of 98°C to conform to UK legislative limits. Spout exit temperatures will vary according to environmental changes and usage patterns.



TECHNICAL SUPPORT

Choosing the right mixer tap and sink for your home is an important choice as the tap is not only the most architectural item in your kitchen, but also the most used.

Think about the style you require, the ease of use you are looking for, and then consider your existing water supply and the water pressure available to you. If you have any questions with regards to whether a tap will be suitable for your application, please contact our technical support team or visit our website www.abodedesigns.co.uk for more details.

For sinks, consider the material and colour you prefer, the uses of the sink, the number and bowl sizes, the type of worktop material you propose to use and the base unit space available to install within.

Your long-term satisfaction with the product is important to us. In the event that you require spare parts for your Abode product, please contact our technical support team or visit our web site for further technical information.

Scan to visit our YouTube channel for support videos.



THE SMALL PRINT

Abode is a division of Norcros Group (Holdings) Limited.

Abode, Distinctly, More is Less, Aquifier, Proboil and Pronteau are registered trademarks of Abode.

Errors and omissions excepted.

Our policy is to continually improve and develop our products, and accordingly we reserve the right to amend specifications, particulars of weights, measures, prices, dimensions, finish and colour availability without prior notice.

For pricing please refer to our separate price list or company website. All prices displayed include VAT at 20% and are the manufacturers' recommended prices only.

April 2023

Abode would like to thank:

Second Nature Kitchens, Daval Furniture, CRL Stone (with photography by Paul Craig), Home Design HQ, Janus Interiors, Kings Kitchens, Leicht Contracts, Stag Kitchens and @newbuildtohome for the use of their beautiful products in the photography used in this brochure.

Design:

Stephanie Masters
0747 500 1066

Photography:

Iain Klieve Photographer
07391 039 289

View the full suite of Abode literature at www.abodedesigns.co.uk

abode

Zenith Park,
Whaley Road,
Barnsley,
South Yorkshire
S75 1HT
Tel: 01226 283434

www.abodedesigns.co.uk
www.pronteau.co.uk

April 2023